



PRESTIGE line

KVALITET I SIGURNOST U PROIZVODNJI
ELEKTROMATERIJALA

PRESTIGE line

QUALITY AND SAFETY IN PRODUCTION
OF ELECTRICAL INSTALLATION MATERIALS



Sklopke i priključnice PRESTIGE line oplemenjene su jednostavnošću tehničkih rešenja i izuzetno lakom ugradnjom.

Izrađene su savremenim tehnološkim postupkom od visokokvalitetnih materijala.

PRESTIGE line switches and socket outlets are enriched due to their simplicity of technical solutions and very simple installation.

Products are made by modern technological process and with high quality materials.

 **ALING-CONEL**

DIZAJN OBLIKUJE NAŠ SVET

PRESTIGE line

DESIGN SHAPES OUR WORLD



Dizajn i boje PRESTIGE line programa
savršeno se uklapaju u vaše enterijere.

*Design and colours of PRESTIGE line
perfectly match with your interiors.*

VRLO JEDNOSTAVAN - VEOMA IZRAŽAJAN - KLASIČAN
VERY SIMPLE - VERY EXPRESSIVE - CLASICAL

TEHNIČKE PREDNOSTI TECHNICAL ADVANTAGES

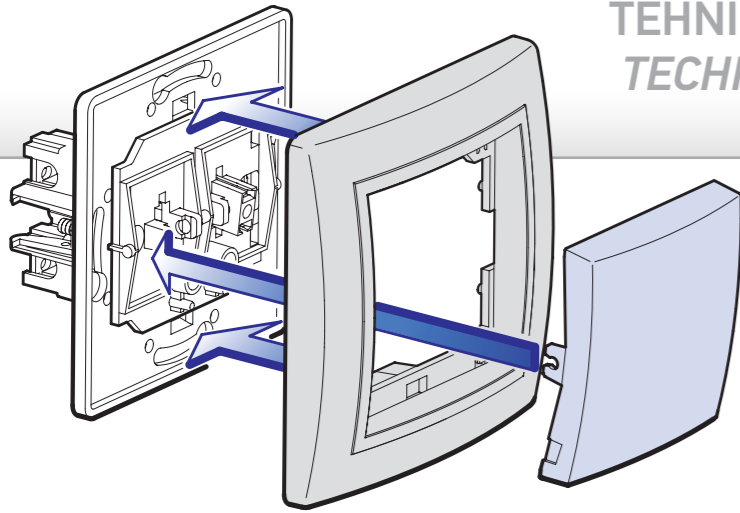

Masku i taster sklopke postavljamo i skidamo veoma jednostavno. Ova kombinacija će Vam i pored jednostavnosti obezbediti dugotrajan i pouzdan rad.
Installation of decorative cover frame and switch button is very simple and easy. Beside simplicity, this combination is providing a long and reliable usage.

BEZVIJČANA MONTAŽA SCREWLESS INSTALLATION

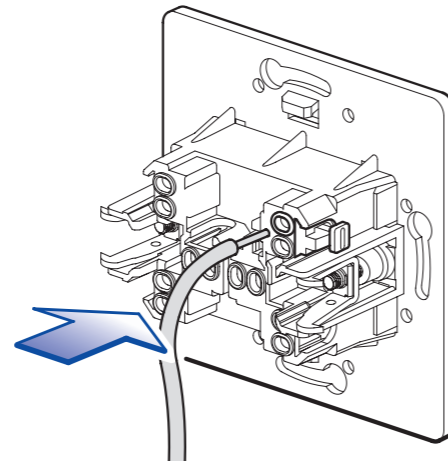

Bezvičajni kontakti omogućuju pouzdanu i brzu montažu do dva provodnika preseka 2,5 mm², bez upotrebe alata za stezanje.

Screwless contacts are allowing safe and fast installation up to two conductors with diameter 2,5 mm², without screwdriver.

VIJČANA MONTAŽA INSTALLATION WITH SCREWS

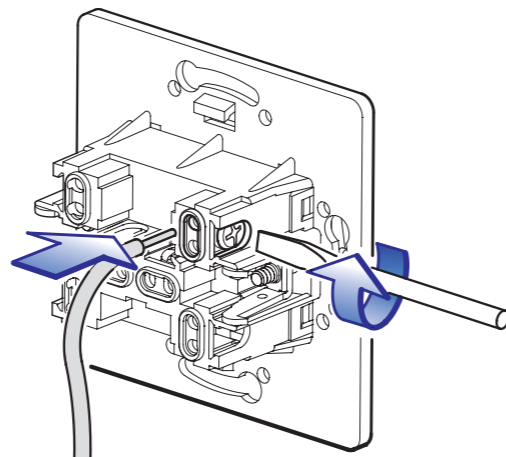

Pritezanje provodnika obezbedeno je pouzdanom i sigurnom vijčanom vezom za provodnike preseka do 4 mm². Priključivanje provodnika je veoma brzo jer je obezbedeno njegovo postavljanje bez mogućnosti isklizavanja tokom pritezanja.

The tightening of conductors is provided by the reliable and safe screw joint for the conductors section to 4 mm². The connecting of conductors is very quick as their setting up is secured without any possibility of slipping out during tightening.

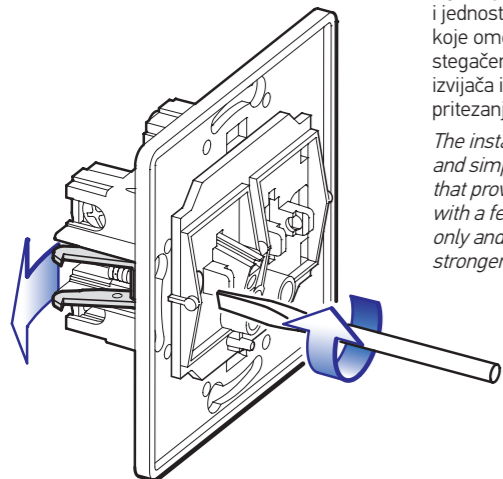

Ugradnja pomoću stegača je brza i jednostavna zahvaljujući rešenju koje omogućava pritezanje stegačem sa vrlo malo okretaja izvijača i bez potrebe jačeg pritezanja vijka.

The installation by clamps is quick and simple thanks to the solution that provides tightening by clamps with a few screwdriver turnings only and without any necessity for stronger screw tightening.

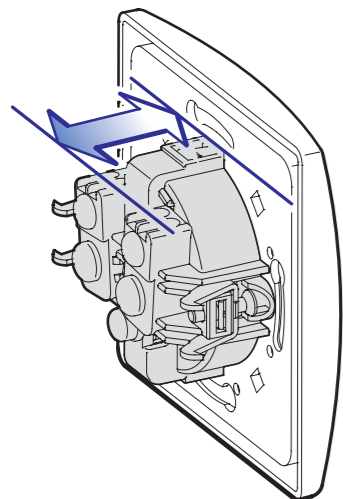

Plastična priključnica je izrađena tako da zauzima veoma malo prostora u montažnoj kutiji čime se montaža pojednostavljuje zbog većeg prostora za smeštaj provodnika.

Socket outlet is made to take a very little space in installation box. Installation is simple because of enough space for conductors.

BOJE PREDNJIH ELEMENATA FRONT ELEMENTS COLORS

art.605.XX

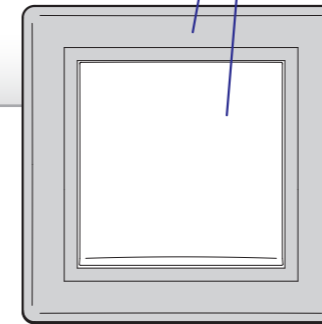

Označavanje sa 2 cifre:

prva cifra - šifra boje maske
druga cifra - šifra boje središnjeg dela (taster, blok)

Marking with 2 digits:

first digit - code of mask with interframe color
second digit - code of middle part color (push-button, block)

Standardno se izrađuju boje:

The standard colors are:

x = 0



Bela
White
RAL 9003

x = 1



Siva
Grey
RAL 7035

x = 2

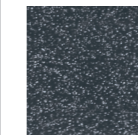

Grafit sa metalik efektom
Graphite with metallic effect
RAL 7021

x = 3



Bordo
Dark red
RAL 3004

x = 9



Krem
Beige
RAL 1013

x = S



Srebrna
Silver

x = E1

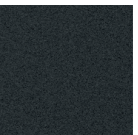

Crna Soft Touch
Black Soft Touch

art.605.XXX

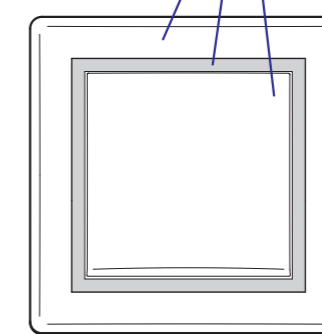

Označavanje sa 3 cifre:

prva cifra - šifra boje maske
druga cifra - šifra boje međurama
treća cifra - šifra boje središnjeg dela (taster, blok)

Marking with 3 digits:

first digit - code of mask color
second digit - code of interframe color
third digit - code of middle part color (push-button, block)

Maske sa međuramom
Frames with interframe

000
Bela
White

S2S
Srebrna, grafit, srebrna
Silver, graphite, silver

330
Bordo, bordo, bela
Dark red, dark red, white

220
Grafit, grafit, bela
Graphite, graphite, white

212
Grafit, siva, grafit
Graphite, grey, graphite

00
Bela
White

99
Krem
Beige

E1E1
Crna Soft Touch
Black Soft Touch

STANDARDNE BOJE
PRESTIGE line
 STANDARD COLORS



Bela
 White



Srebrna, grafit, srebrna
 Silver, graphite, silver



Krem
 Beige



Grafit, grafit, bela
 Graphite, graphite, white

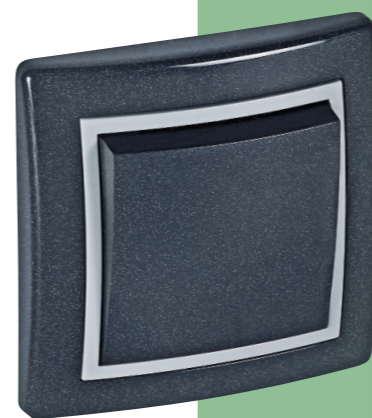

Grafit, siva, grafit
 Graphite, grey, graphite

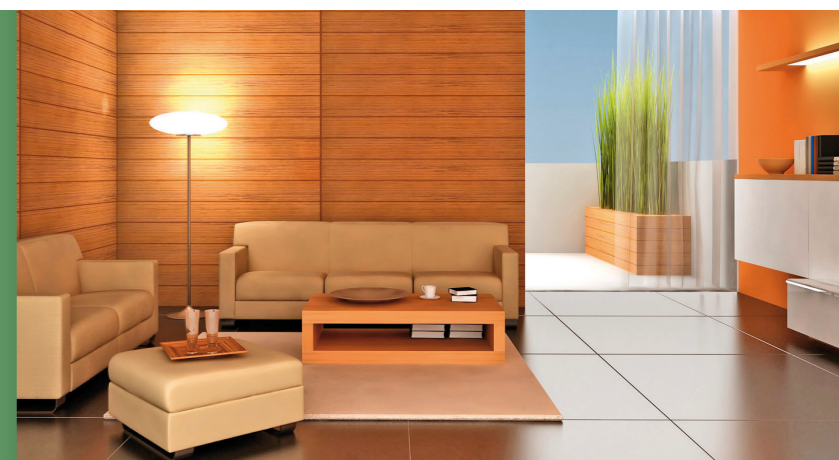

Bordo, bordo, bela
 Dark red, dark red, white



Crna Soft Touch
 Black Soft Touch



PRESTIGE line

SKLOPKE SWITCHES

- Usaglašeno sa IEC 60669-1
- Ugradnja u zid u montažnu kutiju Ø60 pomoću stegača ili vijaka
- Complied with IEC 60669-1
- Wall mounted into the installation box Ø60 by clamps or screws



000
Bela
White

S2S
Srebrna, grafit, srebrna
Silver, graphite, silver



220
Grafit, grafit, bela
Graphite, graphite, white

212
Grafit, siva, grafit
Graphite, grey, graphite



330
Bordo, bordo, bela
Dark red, dark red, white

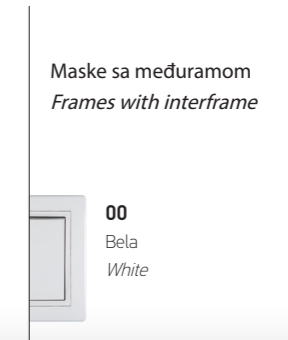

Maske sa međuramom
Frames with interframe

00
Bela
White



E1E1
Crna Soft Touch
Black Soft Touch

99
Krem
Beige



605.xxx
Sklopka jednopolna
10AX/250V~
Single-pole switch
10AX/250V~



608.xxx
Sklopka ukrсна
10AX/250V~
Intermediate switch
10AX/250V~



625.xxx
Sklopka jednopolna
sa indikacijom 10AX/250V~
Single-pole switch
with indication 10AX/250V~

- Indikacija svetli kada je sklopka isključena
- Indication is on when the switch is off



628.xxx
Sklopka ukrсна
sa indikacijom 10AX/250V~
Intermediate switch
with indication 10AX/250V~

- Indikacija svetli kada je strujno kolo otvoreno
- Indication is on when the circuit is open



6052.xxx
Sklopka dvopolna
10AX/250V~
Double-pole switch
10AX/250V~



609.xxx
Taster sklopka za svetlo
bez indikacije
10A/250V~
Light push-button switch
without indication
10A/250V~

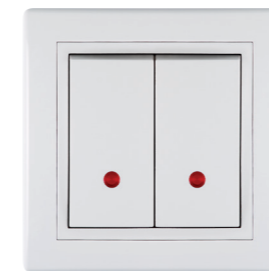

626.xxx
Sklopka serijska
sa indikacijom 10AX/250V~
Serial switch
with indication 10AX/250V~

- Indikacija svetli kada je sklopka isključena
- Indication is on when the switch is off



619.xxx
Sklopka jednopolna
sa indikacijom 16AX/250V~
Single-pole switch
with indication 16AX/250V~

- Indikacija svetli kada je sklopka isključena
- Indication is on when the switch is off



606.xxx
Sklopka serijska
10AX/250V~
Serial switch
10AX/250V~



609I.xxx
Taster sklopka za svetlo
sa indikacijom 10A/250V~
Light push-button switch
with indication 10A/250V~

- Indikacija svetli kada je sklopka isključena
- Indication is on when the switch is off

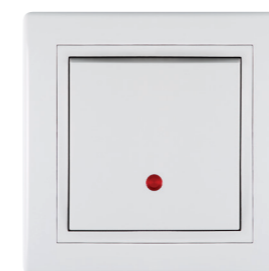

627.xxx
Sklopka naizmjenična
sa indikacijom 10AX/250V~
Two-way switch
with indication 10AX/250V~

- Indikacija svetli kada je strujno kolo otvoreno
- Indication is on when the circuit is open



6191.xxx
Sklopka jednopolna
indikatorska 16AX/250V~
Single-pole switch
with indicator 16AX/250V~

- Indikacija svetli kada je sklopka uključena
- Indication is on when the switch is on



607.xxx
Sklopka naizmjenična
10AX/250V~
Two-way switch
10AX/250V~



610.xxx
Taster sklopka za zvono
bez indikacije
10A/250V~
Bell push-button switch
without indication
10A/250V~



6075.xxx
Taster sklopka za roletne
10A/250V~
Rolling shutter push-button switch
10A/250V~

- Upravljanje kretanjem elektromotora za roletne u dva smera
- Control of shutters' electric motor movement in two directions



6090.xxx
Taster sklopka
10A/250V~
Push-button switch
10A/250V~



6072.xxx
Sklopka naizmjenična
dvostruka 10AX/250V~
Two-way switch double
10AX/250V~



610I.xxx
Taster sklopka za zvono
sa indikacijom 10A/250V~
Bell push-button switch
with indication 10A/250V~

- Indikacija svetli kada je sklopka isključena
- Indication is on when the switch is off



6095.xx
Taster sklopka kartična
PRESTIGE line 10A/250V~
Push-button card switch
PRESTIGE line 10A/250V~

PRESTIGE line

REGULATORI JAČINE SVETLOSTI DIMMERS



617.xxx

Regulator jačine svetlosti sa naizmeničnom sklopkom 40-400VA, 230V~/50Hz

Dimmer with two-way switch 40-400VA, 230V~/50Hz

- Za sijalice sa užarenim vlaknom i halogene sijalice sa standardnim transformatorom
- Usaglašeno sa IEC 60669-2-1
- Ugradnja u zid u montažnu kutiju Ø60 pomoću stegača ili vijaka

- *For incandescent filament lamps and halogen lamps with standard transformer*
- *Complied with IEC 60669-2-1*
- *Wall mounted into the installation box Ø60 by clamps or screws*



6173.xxx

Regulator jačine svetlosti sa rotacionom jednapolnom sklopkom 40-400VA, 230V~/50Hz

Dimmer with rotary single-pole switch 40-400VA, 230V~/50Hz

- Za sijalice sa užarenim vlaknom i halogene sijalice sa standardnim transformatorom
- Usaglašeno sa IEC 60669-2-1
- Ugradnja u zid u montažnu kutiju Ø60 pomoću stegača ili vijaka

- *For incandescent filament lamps and halogen lamps with standard transformer*
- *Complied with IEC 60669-2-1*
- *Wall mounted into the installation box Ø60 by clamps or screws*



6175.xxx

Regulator jačine svetlosti za LED, 1-100W

Dimmer for LED, 1-100W

- Univerzalni elektronski regulator za sve vrste sijalica
- Osnovna namena za CFL i LED dimabilne sijalice 1-100W
- Usaglašeno sa IEC 60669-2-1

- *Universal dimmer for all types of bulbs*
- *The main purpose for dimmable CFL and LED bulbs 1-100W*
- *Complied with IEC 60669-2-1*



PRESTIGE line

PRIKLJUČNICE SOCKET OUTLETS

- Usaglašeno sa IEC 60884-1
- Ugradnja u zid u montažnu kutiju Ø60 pomoću stegača ili vijaka
- *Complied with IEC 60884-1*
- *Wall mounted into the installation box Ø60 by clamps or screws*



600.xxx

Priključnica dvopolna 16A/250V- sa porcelanskim jezgrom

Double-pole socket outlet 16A/250V- with porcelain insert



603.xxx

Priključnica dvopolna sa poklopcem 16A/250V- sa porcelanskim jezgrom

Double-pole socket outlet with cover 16A/250V- with porcelain insert



601.xxx

Priključnica dvopolna 16A/250V- sa porcelanskim jezgrom i zaštitom od dodira

Double-pole socket outlet 16A/250V- with porcelain insert and touch protection



633.xxx

Priključnica dvopolna sa poklopcem 16A/250V- sa polikarbonatskim jezgrom

Double-pole socket outlet with cover 16A/250V- with polycarbonate insert



630.xxx

Priključnica dvopolna 16A/250V- sa polikarbonatskim jezgrom

Double-pole socket outlet 16A/250V- with polycarbonate insert



623.xx

Priključnica dvopolna sa poklopcem 16A/250V-, IP44 sa polikarbonatskim jezgrom

Double-pole socket outlet with cover 16A/250V- IP44 with polycarbonate insert



604.xx

Priključnica dvopolna dvostruka 16A/250V- sa polikarbonatskim jezgrom

Double-pole socket outlet 16A/250V- double with polycarbonate insert

- Nema mogućnost ugradnje u višestruke maske
- *No possibility of mounting into multiple masks*



602.xx

Priključnica tropolna 16A/440V- sa porcelanskim jezgrom

Tripolar socket outlet 16A/440V- with porcelain insert

- Ugradnja u zid u montažnu kutiju Ø70 pomoću vijaka
- *Wall mounted into the installation box Ø70 by screws*

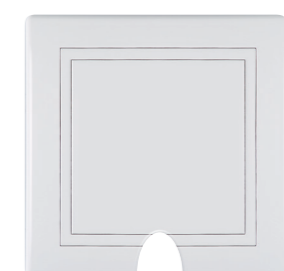

640.x

Kutija za stalni priključak 5 x 2,5 mm² za u zid 440V-

Junction box for continuous connection 5 x 2,2 mm² for into the wall 440V-



PRESTIGE line

PRIKLJUČNICE SOCKET OUTLETS

- Usaglašeno sa IEC 60884-1, NF C 61-314
- Ugradnja u zid u montažnu kutiju Ø60 pomoću stegača ili vijaka
- Complied with IEC 60884-1, NF C 61-314,
- Wall mounted into the installation box Ø60 by clamps or screws



630.04

Priključnica dvopolna 16A/250V~ sa polikarbonatskim jezgrom
Za mreže sa UPS (sa transformatorom) crvena

Double-pole socket outlet 16A/250V~ with polycarbonate insert For power networks with UPS (with transformer) - red



630.0N

Za mreže sa generatorskim napajanjem preko transformatora narandžasta

For power networks with generator supply via transformer - orange



630.012

Za mreže sa zaštićenim generatorskim napajanjem - zelena

For power networks with protected generator supply via transformer green



6045.xx

Priključnica dvopolna dvostruka 16A/250V~ sa polikarbonatskim jezgrom Francuski standard

Double-pole socket outlet 16A/250V~ double with polycarbonate insert French standard

- Nema mogućnost ugradnje u višestruke maske
- No possibility of mounting into multiple masks



635.xxx

Priključnica dvopolna 16A/250V~ Francuski standard

Double-pole socket outlet 16A/250V~ French standard



6350.xxx

Priključnica dvopolna 16A/250V~ sa zaštitom od dodira Francuski standard

Double-pole socket outlet 16A/250V~ with touch protection French standard



6161.xxx

USB punjač 2 x USB 2,1A/5V=
2 x USB charger 2,1A/5V=

- Za punjenje elektronskih uređaja putem standardnog USB porta
- Punjenje dva uređaja istovremeno
- Usaglašeno sa EN 60950-1 EMC direktivom
- For charging of electronic devices via standard USB port
- Enables charging of two devices simultaneously
- Complied with EN 60950-1 and EMC directive



6162.xxx

Priključnica USB/USB Keystone
USB/USB socket Keystone

- Za konekciju USB uređaja i kablova (nije punjač)
- Podržava USB 2.0 standard
- For connection of USB devices and cables (not charging unit)
- Supports USB 2.0 standard



6166.xxx

USB C punjač 3A/5V=
USB C charger 3A/5V=

- Za punjenje elektronskih uređaja putem USB C porta
- Usaglašeno sa EN 60950-1 EMC direktivom
- For charging of electronic devices via USB C port
- Complied with EN 60950-1 and EMC directive



6163.xxx

Priključnica HDMI/HDMI Keystone
HDMI/HDMI socket Keystone

- Za konekciju kablova za prenos signala preko HDMI priključka
- For the transmission of signal through HDMI connector

PRESTIGE line

KOMUNIKACIJE COMMUNICATIONS

- Usaglašeno sa IEC 60603-7
- Ugradnja u zid u montažnu kutiju Ø60 pomoću stegača ili vijaka
- Complied with IEC 60603-7
- Wall mounted into the installation box Ø60 by clamps or screws



611.xxx

Priključnica telefonska dvostruka RJ12 6/2 sa dve odvojene linije

Double telephone socket RJ12 6/2 with two separate lines



613.xxx RJ12 6/4 Cat3

Priključnica telefonska dvostruka sa Keystone modulima

Double telephone socket with Keystone modules bez upotrebe alata

- Toolless conducting wire installation



614.xxx

Priključnica komunikacijska sa Keystone modulima dvostruka RJ45 Cat5e UTP

Data socket double with Keystone modules RJ45 Cat5e UTP

- Montaža provodnika bez upotrebe alata
- Spajanje prema TIA/EIA-568A ili 568B standardu za raspored parica
- Toolless conducting wire installation
- Wiring according to TIA/EIA-568A or 568B standard for the arrangement of pairs



614S.xxx

Priključnica komunikacijska sa Keystone modulima dvostruka RJ45 Cat5e FTP

Data socket double with Keystone modules RJ45 Cat5e FTP (shielded)

- Montaža provodnika bez upotrebe alata
- Spajanje prema TIA/EIA-568A ili 568B standardu za raspored parica
- Toolless conducting wire installation
- Wiring according to TIA/EIA-568A or 568B standard for the arrangement of pairs



615.xxx

Priključnica komunikacijska sa Keystone modulima dvostruka RJ45 Cat6 UTP

Data socket double with Keystone modules RJ45 Cat6 UTP

- Montaža provodnika bez upotrebe alata
- Spajanje prema TIA/EIA-568A ili 568B standardu za raspored parica
- Toolless conducting wire installation
- Wiring according to TIA/EIA-568A or 568B standard for the arrangement of pairs



615S.xxx

Priključnica komunikacijska sa Keystone modulima dvostruka RJ45 Cat6 FTP

Data socket double with Keystone modules RJ45 Cat6 FTP (shielded)

- Montaža provodnika bez upotrebe alata
- Spajanje prema TIA/EIA-568A ili 568B standardu za raspored parica
- Toolless conducting wire installation
- Wiring according to TIA/EIA-568A or 568B standard for the arrangement of pairs



616.xxx

Priključnica komunikacijska sa Keystone modulom RJ45 Cat6A UTP

Data socket with Keystone module RJ45 Cat6A UTP

- Montaža provodnika bez upotrebe alata
- Spajanje prema TIA/EIA-568A ili 568B standardu za raspored parica
- Toolless conducting wire installation
- Wiring according to TIA/EIA-568A or 568B standard for the arrangement of pairs



616S.xxx

Priključnica komunikacijska sa Keystone modulom RJ45 Cat6A FTP

Data socket with Keystone module RJ45 Cat6A FTP (shielded)

- Montaža provodnika bez upotrebe alata
- Spajanje prema TIA/EIA-568A ili 568B standardu za raspored parica
- Toolless conducting wire installation
- Wiring according to TIA/EIA-568A or 568B standard for the arrangement of pairs

PRESTIGE line

KOMUNIKACIJE COMMUNICATIONS

- Usaglašeno sa IEC 60169-2
- Ugradnja u zid u montažnu kutiju Ø60 pomoću stegača ili vijaka
- Complied with IEC 60169-2
- Wall mounted into the installation box Ø60 by clamps or screws

PRESTIGE line

MEHANIZMI BEZ MASKE I MEĐURAMA MECHANISMS WITHOUT COVER FRAME AND INTERFRAME



612L.xxx

Priključnica antenska TV završna za individualne sisteme

TV aerial socket for individual systems

- Muški konektor
- Odvodno slabljenje signala <1 dB
- Male connector
- Connection attenuation <1 dB



612P.xxx

Priključnica antenska TV/FM prolazna
TV/FM aerial socket transient

- Muški konektor TV, ženski konektor FM
- Prolazno slabljenje 4 dB, odvodno 6 dB, sprega TV/FM >20 dB
- Male connector TV, female connector FM
- Throughpass attenuation 4 dB, connection atten. 6 dB, coupling TV/FM >20 dB



612Z.xxx

Priključnica antenska TV/FM završna
TV/FM aerial socket terminal

- Muški konektor TV, ženski konektor FM
- Odvodno slabljenje <2 dB, sprega TV/FM >20 dB
- Male connector TV, female connector FM
- Connection attenuation <2 dB, coupling attenuation TV/FM >20 dB



612S.xxx

Priključnica antenska TV/FM/SAT završna
TV/FM/SAT aerial socket terminal

- Muški konektor TV, ženski konektor FM
- SAT konektor IEC 60169-24 (F tip)
- Odvodno slabljenje <2 dB, sprega TV/FM >20 dB
- Male connector TV, male connector FM
- SAT connector IEC 60169-24 (F type)
- Connection attenuation <2 dB, coupling attenuation TV/FM >20 dB

PRESTIGE line



Za ugradnju u višestruke maske proizvodi PRESTIGE line isporučuju se bez pripadajuće maske i međurama, čime je omogućeno da korisnik sam kombinuje boje i grupisanje komponenti. Uz svaki mehanizam isporučuje se taster ili blok u standardnim bojama.

For the installation into the multiple masks, the products of PRESTIGE line are supplied without the pertaining frame and interframe thus enabling the user to make the combination of colours and grouping of components. Each mechanism is supplied with button or the block in standard colours.

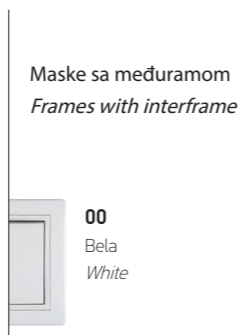
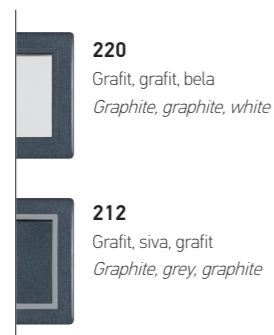

- Usaglašeno sa IEC 60669-1
- Ugradnja u zid u montažnu kutiju Ø60 pomoću stegača ili vijaka

- Complied with IEC 60669-1
- Wall mounted into the installation box Ø60 by clamps or screws



6005.x

Sklopka jednopolna
10AX/250V~
Single-pole switch
10AX/250V~



6009.x

Taster sklopka za svetlo
bez indikacije
10A/250V~
Light push-button switch
without indication
10A/250V~



6027.x

Sklopka naizmjenična
sa indikacijom 10AX/250V~
Two-way switch
with indication 10AX/250V~

- Indikacija svetli kada je strujno kolo otvoreno
- Indication is on when the circuit is open



6000.x

Priključnica dvopolna 16A/250V~
sa porcelanskim jezgrom
Double-pole socket outlet
16A/250V~ with porcelain insert



60052.x

Sklopka dvopolna
10AX/250V~
Double-pole switch
10AX/250V~



60091.x

Taster sklopka za svetlo
sa indikacijom 10A/250V~
Light push-button switch
with indication 10A/250V~

- Indikacija svetli kada je sklopka isključena
- Indication is on when the switch is off

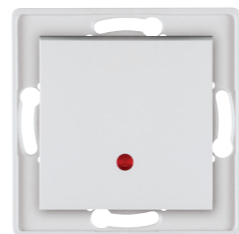

6028.x

Sklopka ukrсна
sa indikacijom 10AX/250V~
Cross switch
with indication 10AX/250V~

- Indikacija svetli kada je strujno kolo otvoreno
- Indication is on when the circuit is open



6001.x

Priključnica dvopolna 16A/250V~
sa porcelanskim jezgrom
i zaštitom od dodira
Double-pole socket outlet
16A/250V~ with porcelain insert
and touch protection

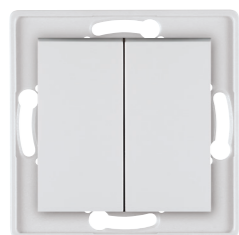

6006.x

Sklopka serijska
10AX/250V~
Serial switch
10AX/250V~



6010.x

Taster sklopka za zvono
bez indikacije
10A/250V~
Bell push-button switch
without indication
10A/250V~

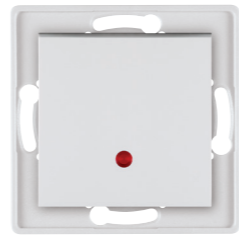

6019.x

Sklopka jednopolna
sa indikacijom 16AX/250V~
Single-pole switch
with indication 16AX/250V~

- Indikacija svetli kada je strujno kolo otvoreno
- Indication is on when the circuit is open



6030.x

Priključnica dvopolna
16A/250V~ sa polikarbonatskim jezgrom
Double-pole socket outlet
16A/250V~ with polycarbonate insert



6030.4 6030.N 6030.12

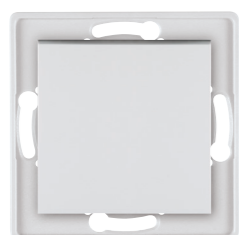

6007.x

Sklopka naizmjenična
10AX/250V~
Two-way switch
10AX/250V~



60101.x

Taster sklopka za zvono
sa indikacijom 10A/250V~
Bell push-button switch
with indication 10A/250V~

- Indikacija svetli kada je sklopka isključena
- Indication is on when the switch is off

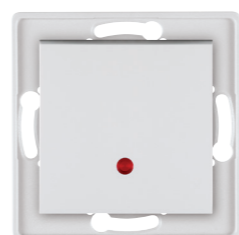

60191.x

Sklopka jednopolna
indikatorska 16AX/250V~
Single-pole switch
with indication 16AX/250V~

- Indikacija svetli kada je sklopka uključena
- Indication is on when the switch is on



6003.x

Priključnica dvopolna
sa poklopcem 16A/250V~
sa porcelanskim jezgrom
Double-pole socket outlet
with cover 16A/250V~
with porcelain insert

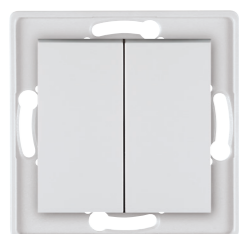

60072.x

Sklopka naizmjenična
dvostruka 10AX/250V~
Two-way switch double
10AX/250V~

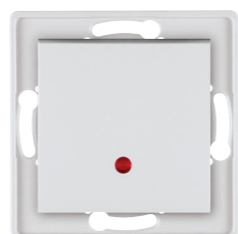

6025.x

Sklopka jednopolna
sa indikacijom 10AX/250V~
Single-pole switch
with indication 10AX/250V~

- Indikacija svetli kada je sklopka isključena
- Indication is on when the switch is off



60075.x

Taster sklopka za roletne
10A/250V~
Rolling shutter push-button switch
10A/250V~

- Upravljanje kretanjem elektromotora za roletne u dva smera
- Control of shutters' electric motor movement in two directions



6033.x

Priključnica dvopolna
sa poklopcem 16A/250V~
sa polikarbonatskim jezgrom
Double-pole socket outlet
with cover 16A/250V~
with polycarbonate insert



6008.x

Sklopka ukrсна
10AX/250V~
Intermediate switch
10AX/250V~

60090.x

Taster sklopka
10A/250V~
Push-button switch
10A/250V~

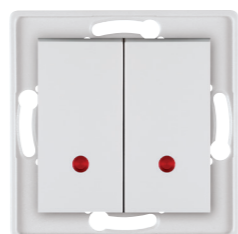

6026.x

Sklopka serijska
sa indikacijom 10AX/250V~
Serial switch
with indication 10AX/250V~

- Indikacija svetli kada je sklopka isključena
- Indication is on when the switch is off



6035.x

Priključnica dvopolna 16A/250V~
Francuski standard
Double-pole socket outlet 16A/250V~
French standard

- Usaglašeno sa NF C 61-314
- Complied with NF C 61-314



60350.x

Priključnica dvopolna 16A/250V~
sa zaštitom od dodira
Francuski standard
Double-pole socket outlet 16A/250V~
with touch protection
French standard

- Usaglašeno sa NF C 61-314
- Complied with NF C 61-314

- Usaglašeno sa IEC 60669-2-1
- Ugradnja u zid u montažnu kutiju Ø60 pomoću stegača ili vijaka

- Complied with IEC 60669-2-1
- Wall mounted into the installation box Ø60 by clamps or screws



6017.x

Regulator jačine svetlosti sa naizmeničnom sklopkom 40-400VA, 230V~/50Hz

Dimmer with two-way switch 40-400VA, 230V~/50Hz

- Za sijalice sa užarenim vlaknom i halogene sijalice sa standardnim transformatorom,
- For incandescent filament lamps and halogen lamps with standard transformer



6011.x

Priključnica telefonska dvostruka RJ12 6/2 sa dve odvojene linije

Double telephone socket RJ12 6/2 with two separate lines

- Usaglašeno sa IEC 60603-7
- Ugradnja u zid u montažnu kutiju Ø60 pomoću stegača ili vijaka

- Complied with IEC 60603-7
- Wall mounted into the installation box Ø60 by clamps or screws



6014.x

Priključnica komunikacijska sa Keystone modulima dvostruka RJ45 Cat5e UTP

Data socket double with Keystone modules RJ45 Cat5e UTP

- Usaglašeno sa IEC 60169-2
- Ugradnja u zid u montažnu kutiju Ø60 pomoću stegača ili vijaka



6012I.x

Priključnica antenska TV završna za individualne sisteme

TV aerial socket for individual systems

- Muški konektor
- Odvodno slabljenje signala <1 dB
- Male connector
- Connection attenuation <1 dB



60173.x

Regulator jačine svetlosti sa rotacionom jednopolnom sklopkom 40-400VA, 230V~/50Hz

Dimmer with rotary single-pole switch 40-400VA, 230V~/50Hz

- Za sijalice sa užarenim vlaknom i halogene sijalice sa standardnim transformatorom,
- For incandescent filament lamps and halogen lamps with standard transformer



6013.x

Priključnica telefonska dvostruka sa Keystone modulima RJ12 6/6 Cat 3

Double telephone socket with Keystone modules RJ12 6/6 Cat 3

- Montaža provodnika bez upotrebe alata
- Toolless conducting wire installation



6014S.x

Priključnica komunikacijska sa Keystone modulima dvostruka RJ45 Cat5e FTP

Data socket double with Keystone modules RJ45 Cat5e FTP



6012Z.x

Priključnica antenska TV/FM završna

TV/FM aerial socket terminal

- Muški konektor TV, ženski konektor FM
- Odvodno slabljenje <2 dB, sprega TV/FM >20 dB
- Male connector TV, female connector FM
- Connection attenuation <2 dB, coupling attenuation TV/FM >20 dB



60175.x

Regulator jačine svetlosti za LED, 100W

Dimmer for LED, 100W

- Univerzalni elektronski regulator za sve vrste sijalica;
- Osnovna namena za CFL i LED dimabilne sijalice 0-100W;
- Universal dimmer for all types of bulbs;
- The main purpose for dimmable CFL and LED bulbs 0-100W;



60131.x

Priključnica telefonska dvostruka sa Keystone modulima RJ12 6/6 Cat 3

Double telephone socket with Keystone modules RJ12 6/6 Cat 3

- Montaža provodnika bez upotrebe alata
- Toolless conducting wire installation



6015.x

Priključnica komunikacijska sa Keystone modulima dvostruka RJ45 Cat6 UTP

Data socket double with Keystone modules RJ45 Cat6 UTP



6012P.x

Priključnica antenska TV/FM prolazna

TV/FM aerial socket transient

- Muški konektor TV, ženski konektor FM
- Prolazno slabljenje 4 dB, odvodno 6 dB, sprega TV/FM >20 dB
- Male connector TV, female connector FM
- Throughpass attenuation 4 dB, connection atten. 6 dB, coupling TV/FM >20 dB

- Usaglašeno sa EN 60950-1 EMC direktivom;
- Ugradnja u zid u montažnu kutiju Ø60 pomoću stegača ili vijaka

- Complied with EN 60950-1 and EMC directive;
- Wall mounted into the installation box Ø60 by clamps or screws



60161.x

USB punjač 2 x USB 2,1A 5V=

2 x USB charger 2,1A 5V=

- Za punjenje elektronskih uređaja putem standardnog USB porta;
- Punjenje dva uređaja istovremeno;
- For charging of electronic devises via standard USB port;
- Enables charging of two devices simultaneously;



60162.x

Priključnica USB/USB Keystone

USB/USB socket Keystone

- Za konekciju USB uređaja i kablova (nije punjač);
- Podržava USB 2.0 standard;
- For connection of USB devices and cables (not charging unit);
- Supports USB 2.0 standard;



6015S.x

Priključnica komunikacijska sa Keystone modulima dvostruka RJ45 Cat6 FTP

Data socket double with Keystone modules RJ45 Cat6 FTP

- Montaža provodnika bez upotrebe alata
- Spajanje prema TIA/EIA-568A ili 568B standardu za raspored parica
- Toolless conducting wire installation
- Wiring according to TIA/EIA-568A or 568B standard for the arrangement of pairs



6012S.x

Priključnica antenska TV/FM/SAT završna

TV/FM/SAT aerial socket terminal

- Muški konektor TV, ženski konektor FM
- SAT konektor IEC 60169-24 (F tip)
- Odvodno slabljenje <2 dB, sprega TV/FM >20 dB
- Male connector TV, male connector FM
- SAT connector IEC 60169-24 (F type)
- Connection attenuation <2 dB, coupling attenuation TV/FM >20 dB



60166.x

USB C punjač 3A 5V=

USB C charger 3A 5V=

- Za punjenje elektronskih uređaja putem USB C porta;
- Usaglašeno sa EN 60950-1 EMC direktivom;
- For charging of electronic devises via USB C port;
- Complied with EN 60950-1 and EMC directive;



60163.x

Priključnica HDMI/HDMI Keystone

HDMI/HDMI socket Keystone

- Za konekciju kablova za prenos signala preko HDMI priključka;
- For the transmission of signal through HDMI connector;



6016.x

Priključnica komunikacijska sa Keystone modulom RJ45 Cat6A UTP

Data socket with Keystone module RJ45 Cat6A UTP

- Montaža provodnika bez upotrebe alata
- Spajanje prema TIA/EIA-568A ili 568B standardu za raspored parica
- Toolless conducting wire installation
- Wiring according to TIA/EIA-568A or 568B standard for the arrangement of pairs



6016S.x

Priključnica komunikacijska sa Keystone modulom RJ45 Cat6A FTP

Data socket with Keystone module RJ45 Cat6A FTP (shielded)

- Montaža provodnika bez upotrebe alata
- Spajanje prema TIA/EIA-568A ili 568B standardu za raspored parica
- Toolless conducting wire installation
- Wiring according to TIA/EIA-568A or 568B standard for the arrangement of pairs



	Bela White	x = 0		Grafit Graphite	x = 2		Bordo Dark red	x = 3
	Crna Soft Touch Black Soft Touch	x = E1		Krem Beige	x = 9		Srebrna Silver	x = S

PRESTIGE line

MASKE I MEĐURAMOVI COVER FRAMES AND INTERFRAMES

- Usaglašeno sa IEC 60669-1 i IEC 60884-1
- Za ugradnju na PRESTIGE LINE mehanizme ugrađene u zid u nizajuće dozne za višestruke maske (osno rastojanje 71 mm)
- Complied with IEC 60669-1 and IEC 60884-1
- For mounting onto PRESTIGE LINE mechanisms wall mounted in a sequence of boxes for multiple masks (axial distance 71 mm)

	Bela White	x = 0
	Srebrna Silver	x = S
	Grafit Graphite	x = 2
	Bordo Dark red	x = 3

Maske sa međuramom Frames with interframe		
	Bela White	xx = 00
	Krem Beige	xx = 99
	Crna Soft Touch Black Soft Touch	xx = E1E1

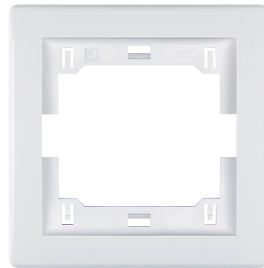

6801.x
Maska jednostruka
PRESTIGE line
*One-gang frame
PRESTIGE line*



6811.xx
Maska jednostruka
sa međuramom
PRESTIGE line
*One-gang frame
with interframe
PRESTIGE line*

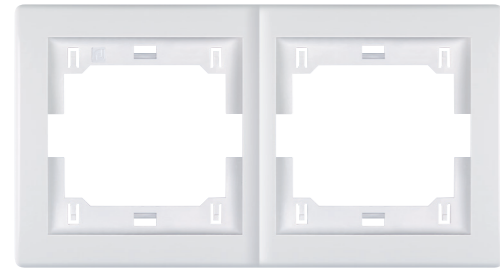

6701.x
Maska dvostruka
PRESTIGE line
horizontalna
*Two-gang frame
PRESTIGE line
horizontal*

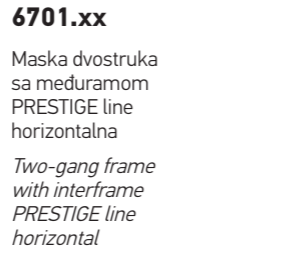

6701.xx
Maska dvostruka
sa međuramom
PRESTIGE line
horizontalna
*Two-gang frame
with interframe
PRESTIGE line
horizontal*

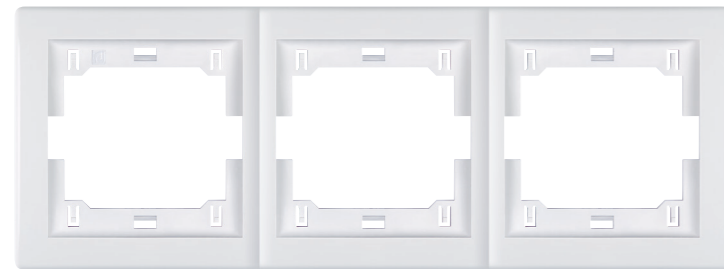

6703.x
Maska trostruka
PRESTIGE line
horizontalna
*Three-gang frame
PRESTIGE line
horizontal*

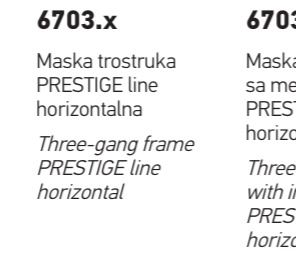

6703.xx
Maska trostruka
sa međuramom
PRESTIGE line
horizontalna
*Three-gang frame
with interframe
PRESTIGE line
horizontal*

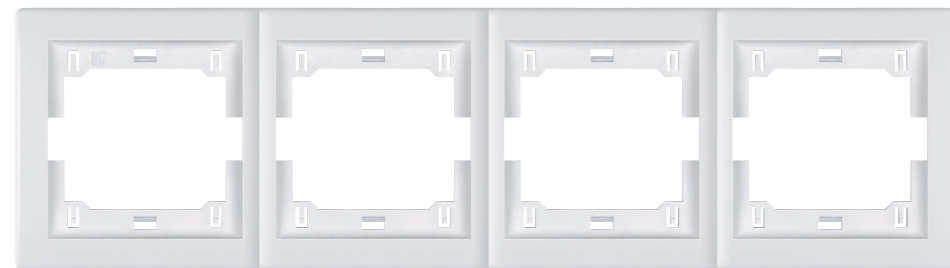

6704.x
Maska četvorostuka
PRESTIGE line
horizontalna
*Four-gang frame
PRESTIGE line
horizontal*

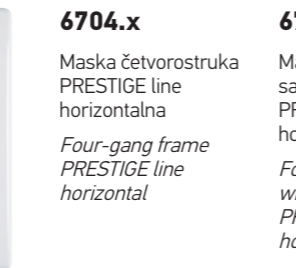

6704.xx
Maska četvorostuka
sa međuramom
PRESTIGE line
horizontalna
*Four-gang frame
with interframe
PRESTIGE line
horizontal*

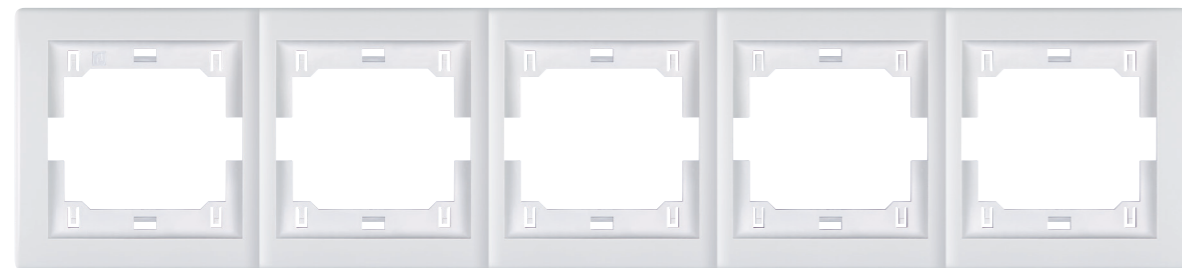

6705.x
Maska petostruka
PRESTIGE line - horizontalna
*Five-gang frame
PRESTIGE line - horizontal*

6705.xx
Maska petostruka
sa međuramom
PRESTIGE line - horizontalna
*Five-gang frame
with interframe
PRESTIGE line - horizontal*

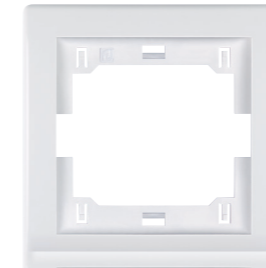

6711.x
Maska dvostruka
PRESTIGE line
vertikalna
*Two-gang frame
PRESTIGE line
vertical*

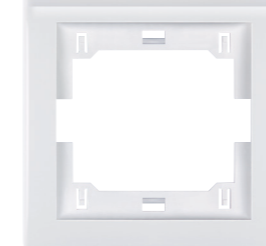

6711.xx
Maska dvostruka
sa međuramom
PRESTIGE line
vertikalna
*Two-gang frame
with interframe
PRESTIGE line
vertical*

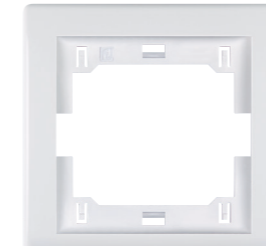

6713.x
Maska trostruka
PRESTIGE line
vertikalna
*Three-gang frame
PRESTIGE line
vertical*

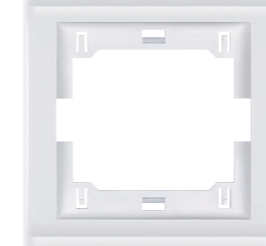

6713.xx
Maska trostruka
sa međuramom
PRESTIGE line
vertikalna
*Three-gang frame
with interframe
PRESTIGE line
vertical*

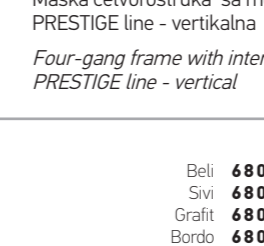
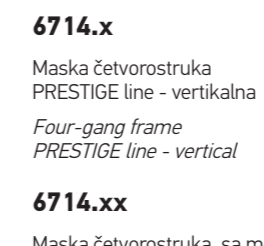
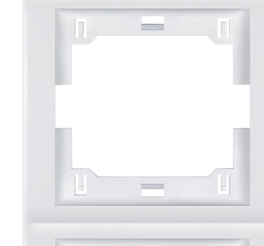
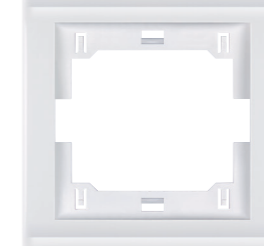
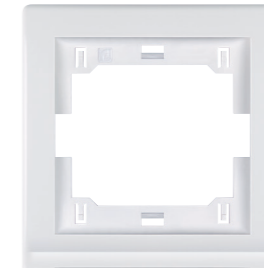

6802.x
Međuram PRESTIGE line
Interframe PRESTIGE line



- Usaglašeno sa IEC 60669-1 i IEC 60884-1
- Za ugradnju na PRESTIGE line maske kao ukrasni element
- Complied with IEC 60669-1 and IEC 60884-1
- For mounting onto PRESTIGE line frames, like decorative element

Beli	6802.0	White
Sivi	6802.1	Grey
Grafit	6802.2	Graphite
Bordo	6802.3	Dark red
Crveni	6802.4	Red
Svetlo plavi	6802.5	Light blue
Teget	6802.6	Navy-blue
Svetlo zeleni	6802.7	Light green
Žuti	6802.8	Yellow
Krem	6802.9	Beige
Roze	6802.10	Pink
Zeleni	6802.12	Green
Srebrni	6802.5	Silver
Crni Soft Touch	6802.E1	Black Soft Touch

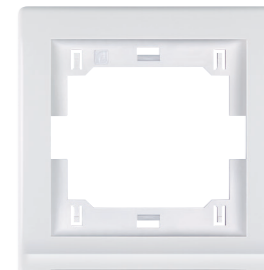

6715.x
Maska petostruka
PRESTIGE line
vertikalna
*Five-gang frame
PRESTIGE line
vertical*

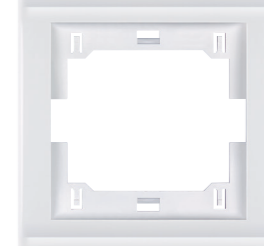

6715.xx
Maska petostruka
sa međuramom
PRESTIGE line
vertikalna
*Five-gang frame
with interframe
PRESTIGE line
vertical*

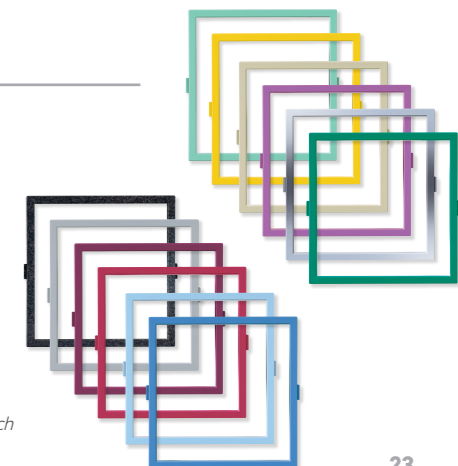
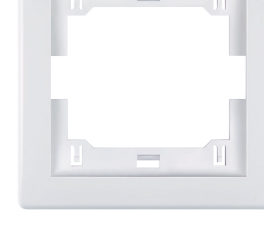
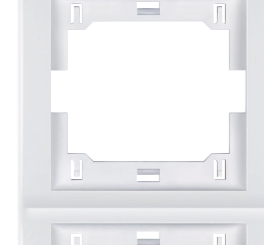
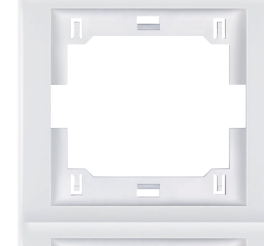



PRESTIGE line

ŠEME VEZIVANJA WIRING DIAGRAMS

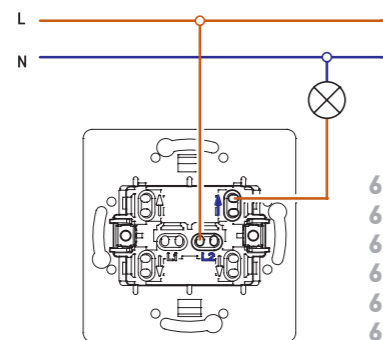
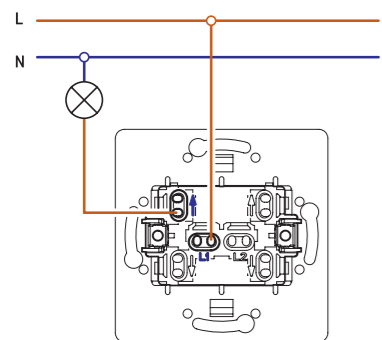

605
6091
610
6101
625
619

Jednopolna sklopka ima dve izvedbe sklapanja (leva i desna) i u skladu s tim se povezuju priključni provodnici.

Single-pole switch is supplied in two wiring executions (left and right) and the conductors are connected accordingly.

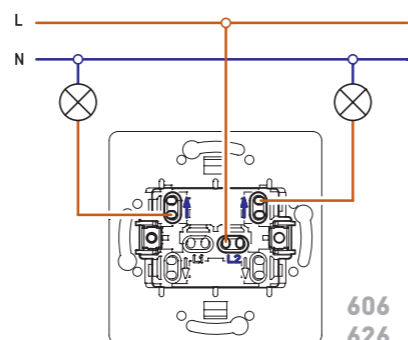

606
626

Serijska sklopka
Serial switch

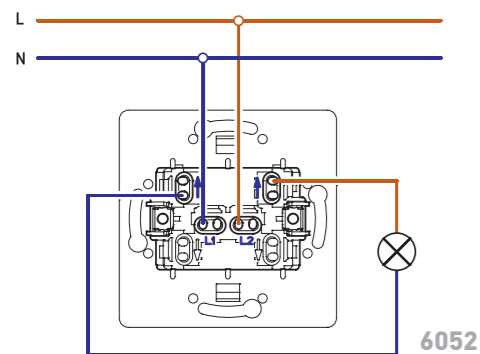

6052

Dvopolna sklopka
Double-pole switch

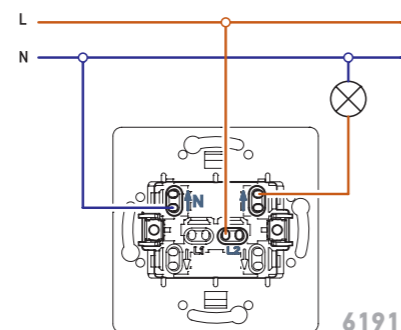

6191

Jednopolne indikatorske sklopke (indikacija svetli kada je sklopka uključena) za povezivanje zahtevaju nulti provodnik
Single-pole indication switches (indication turns on when the switch is on) require neutral conductor to be wired.

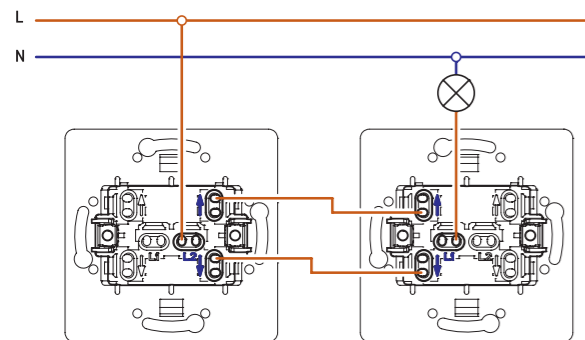

E607
E6072
E627

Naizmjenična sklopka, dve izvedbe sklapanja (leva i desna)
Two-way switch, two wiring executions (left and right)

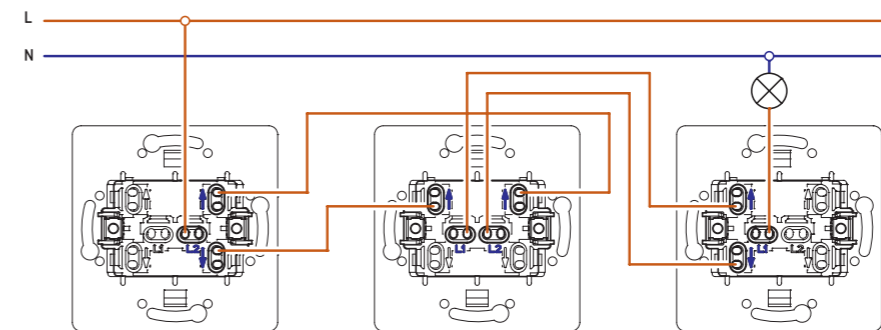
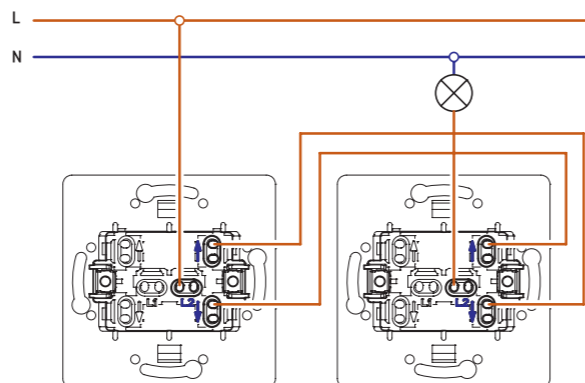

608
628

Ukrsna sklopka se povezuje u kombinaciji sa naizmjeničnim sklopkama. Može se povezati neograničen broj ukrasnih sklopki u kombinaciji sa dve naizmjenične.

Intermediate switch is wired in combination with two-way switches. The unlimited number of intermediate switches may be wired in combination with two two-way switches.

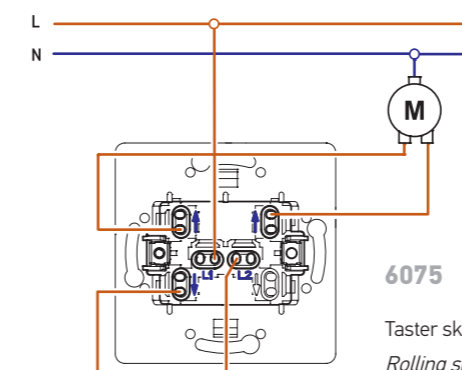

6075

Taster sklopka za roletne
Rolling shutter push-button switch

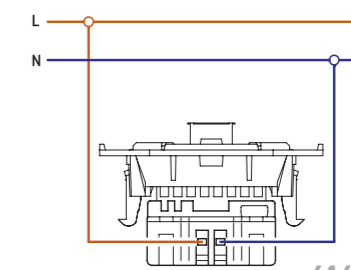

6161

USB punjač
USB charger

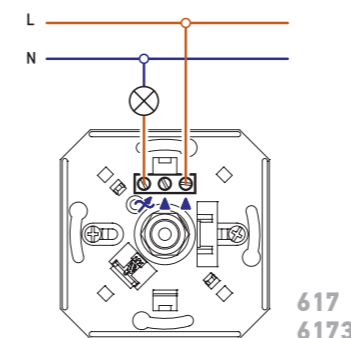

617
6173

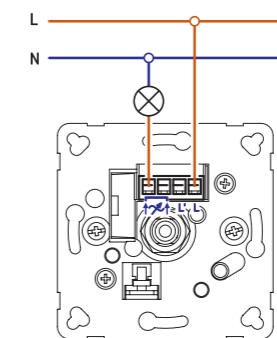

6175

Povezivanje regulatora jačine svetlosti sa naizmjeničnom sklopkom kao jednopolne sklopke i regulatora sa rotacionom jednopolnom sklopkom.

Wiring of dimmer with two-way switch and the dimmer with rotary single-pole switch.

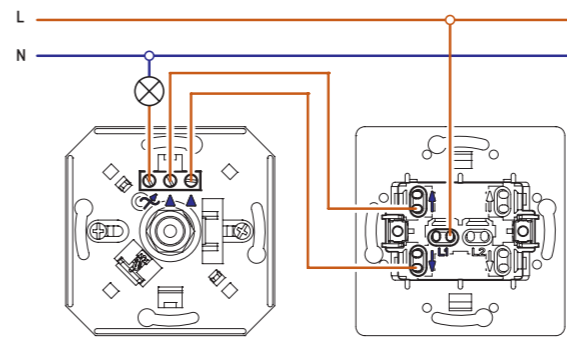

617

Regulator jačine svetlosti sa naizmjeničnom sklopkom može se povezati i u kombinaciji sa naizmjeničnom sklopkom za regulaciju sa jednog mesta i uključivanje i isključivanje sa dva mesta. Međusobno povezivanje više regulatora nije moguće.

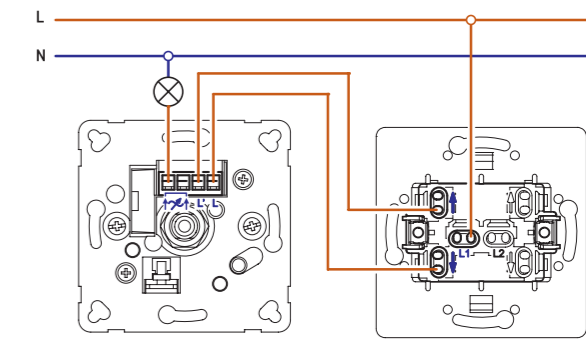

6175

Dimmer with two-way switch may be also wired in combination with two-way switch for the regulation from one place and switching on and off from two places. Inter-wiring of more regulators is not possible.

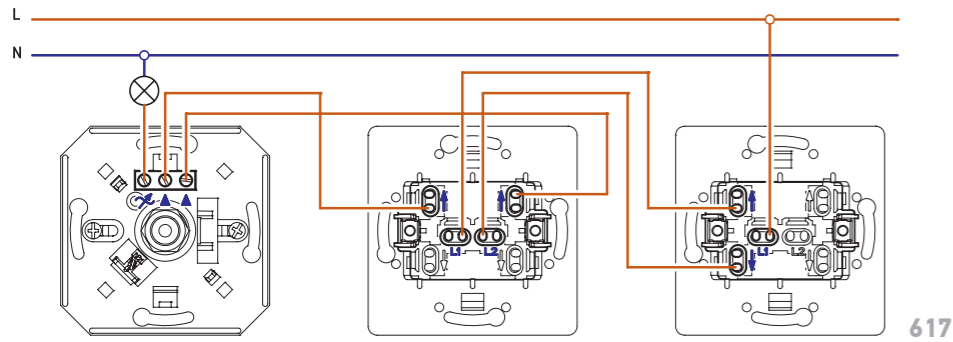

Kombinacijom regulatora sa naizmeničnom sklopkom i ukrsne i naizmenične sklopke omogućava se uključivanje i isključivanje sa proizvoljan broj mesta.

The combination of dimer with two-way switch and intermediate and two-way switch provides the switching on and off from the desirable number of places.

617

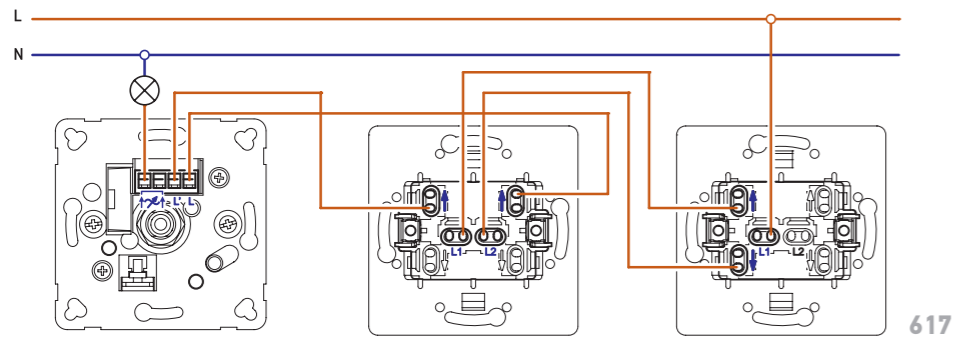

6175

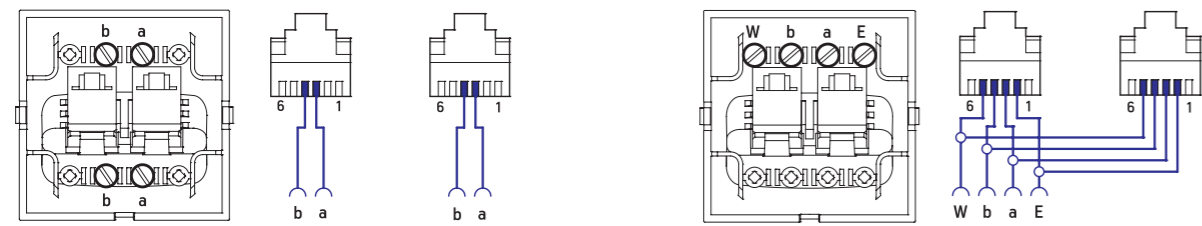

Telefonske priključnice sa standardnim RJ12 konektorima u saglasnosti sa IEC 60603-7 u kombinaciji 2 x 6/2 i 2 x 6/4 kontakta. Povezivanje se vrši prema priloženim šemama gde su kontakti a i b osnovna linija, a W i E kontakti druge parice za analogni terminal (prema internacionalnom standardu).

Telephone sockets with standard RJ12 connectors in compliance with IEC 60603-7 in combination of 2 x 6/2 and 2 x 6/4 contacts. The wiring is carried out in accordance with wiring diagrams where the contacts a and b represent the basic line while W and E are the contacts of the second pair for analogue terminal (according to international standard).

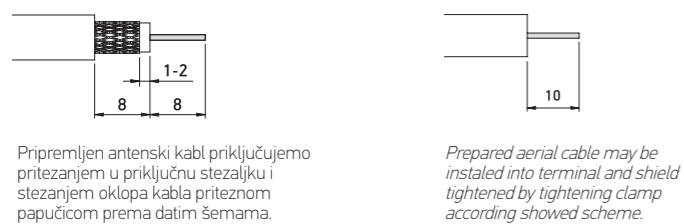

Pripremljen antenski kabl priključujemo pritezanjem u priključnu stezaljku i stezanjem oklopa kabla priteznom papučicom prema datim šemama.

Prepared aerial cable may be installed into terminal and shield tightened by tightening clamp according showed scheme.

Antenski kabl za priključenje na antenske priključnice potrebno je pripremiti prema prikazanoj šemi da bi se postigao siguran kontakt, jednostavno postavljanje i onemogućio eventualni kratak spoj.

For safe contact, simple instaling and short-circuit disabling cable for aerial socket wiring must be prepared according showed scheme.

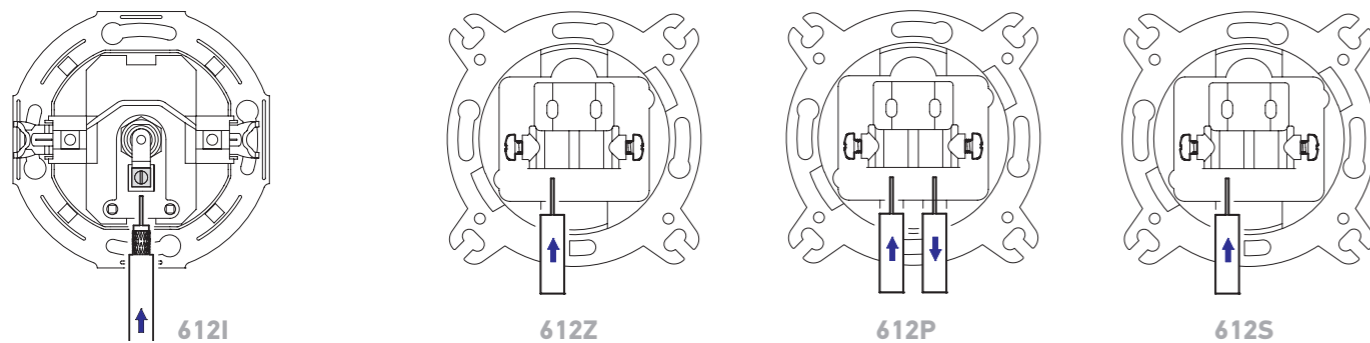

PRESTIGE line

DIMENZIJE ZA UGRADNJU INSTALATION DIMENSIONS

- Osnova maske 80 x 80 mm
- Cover frame base 80 x 80 mm

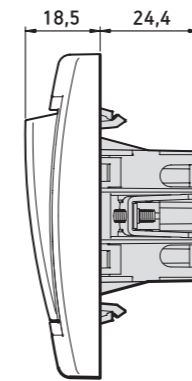
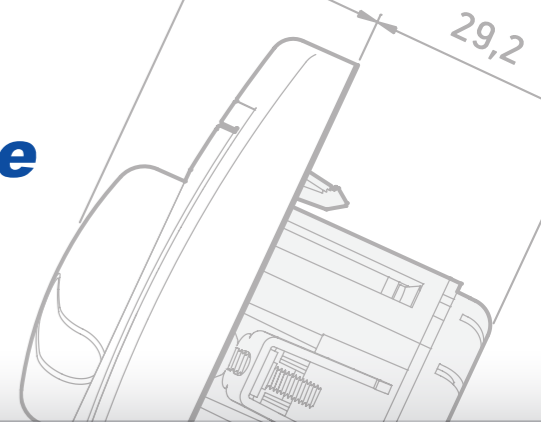

Sklopke
Switches

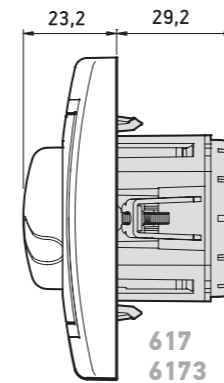

617
6173

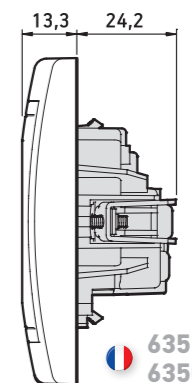

635
6350

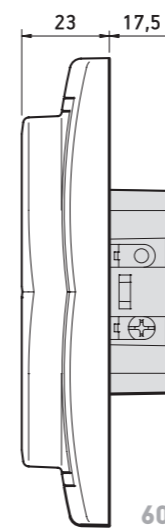

Osnova maske
80 x 123 mm
Cover frame base
80 x 123 mm

604

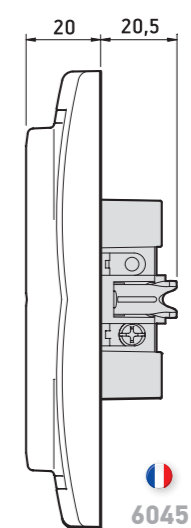

Osnova maske
80 x 123 mm
Cover frame base
80 x 123 mm

6045

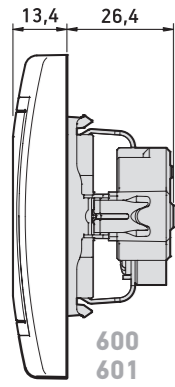

600
601

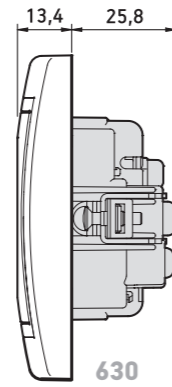

630

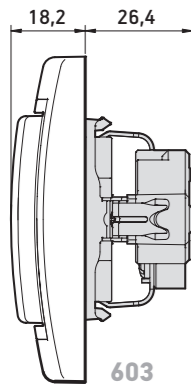

603

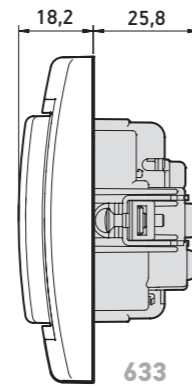

633

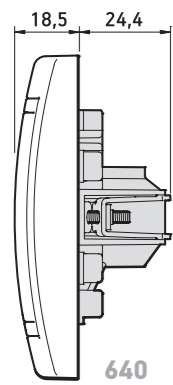

640

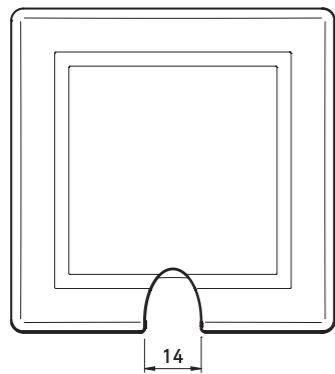

14

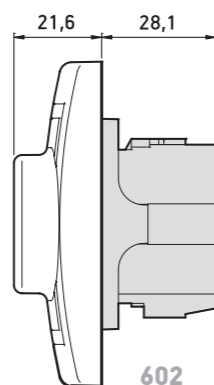

602

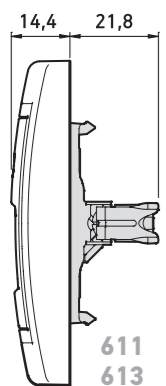

611
613

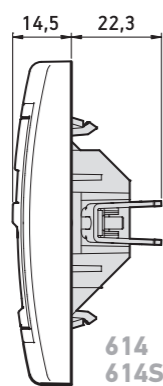

614
614S
615
615S
6131

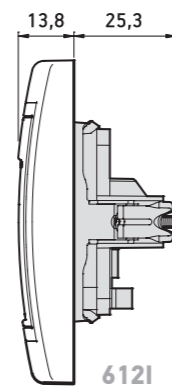

612I

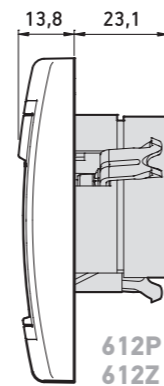

612P
612Z
612S

PRESTIGE line

TEHNIČKI CRTEŽI TECHNICAL DRAWINGS

- Osnova maske 80 x 80 mm
- Cover frame base 80 x 80 mm

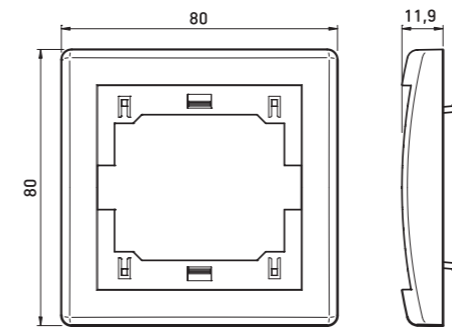
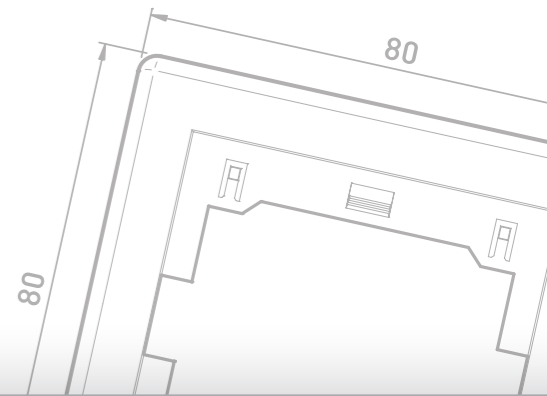

6801

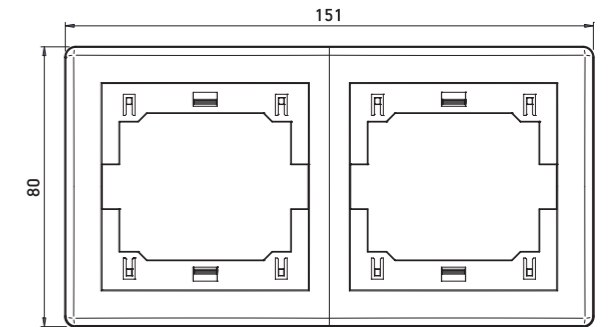

6701
6711

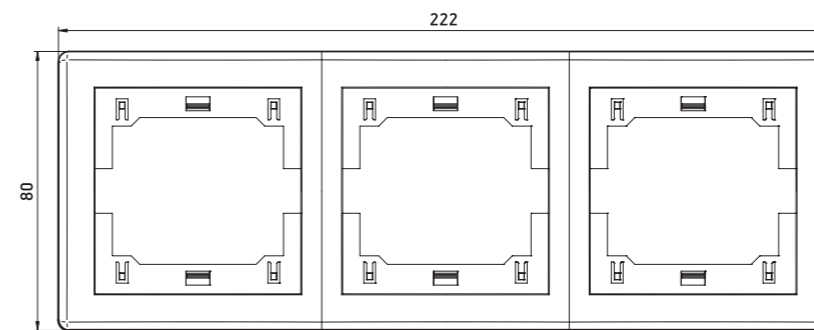

6703
6713

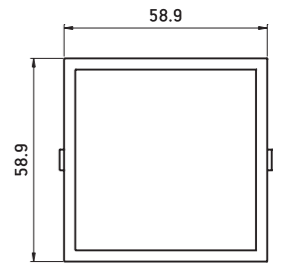

6802

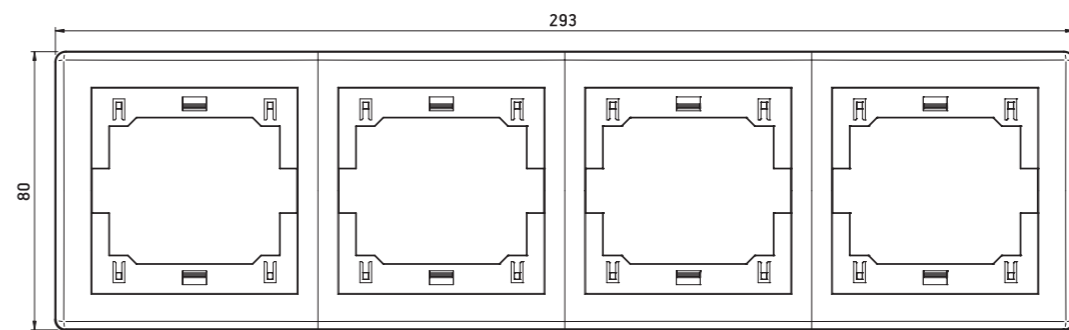

6704
6714

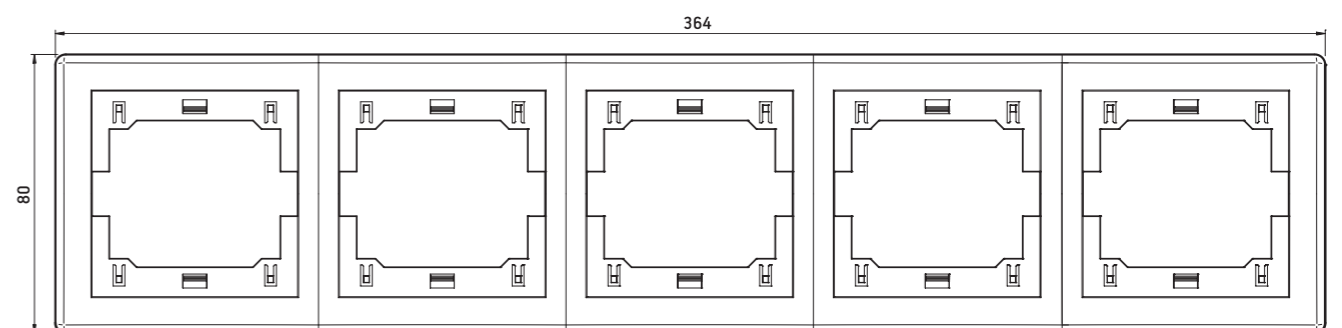

6705
6715

PRESTIGE line

SADRŽAJ KATALOGA
THE CATALOG CONTENT

- 6 TEHNIČKE PREDNOSTI
TECHNICAL ADVANTAGES
- 7 BOJE PREDNJIH ELEMENATA
FRONT ELEMENTS COLORS
- 8 STANDARDNE BOJE
STANDARD COLORS
- 10 SKLOPKE
SWITCHES
- 12 REGULATORI JAČINE SVETLOSTI
DIMMERS
- 13 PRIKLJUČNICE
SOCKET OUTLETS
- 15 KOMUNIKACIJE
COMMUNICATIONS
- 17 MEHANIZMI BEZ MASKE I MEĐURAMA
MECHANISMS WITHOUT COVER FRAME AND INTERFRAME
- 22 MASKE I MEĐURAMOVI
COVER FRAMES AND INTERFRAMES
- 24 ŠEME VEZIVANJA
WIRING DIAGRAMS
- 27 DIMENZIJE ZA UGRADNJU
INSTALLATION DIMENSIONS
- 29 TEHNIČKI CRTEŽI
TECHNICAL DRAWINGS

PRESTIGE line





ALING-CONEL

a: Železnička 10, 21432 Gajdobra, Serbia
t: +381 21 762 674, 762 586
f: +381 21 762 779
e: sales@aling-conel.com
www.aling-conel.com