



# PRESTIGE LINE

KVALITET I SIGURNOST U PROIZVODNJI  
ELEKTROMATERIJALA

## PRESTIGE LINE

QUALITY AND SAFETY IN PRODUCTION  
OF ELECTRICAL INSTALLATION MATERIALS



# PRESTIGE LINE

Sklopke i priključnice PRESTIGE LINE oplemenjene su jednostavnošću tehničkih rešenja i izuzetno lakom ugradnjom.

Izrađene su savremenim tehnološkim postupkom od visokokvalitetnih materijala.

*PRESTIGE LINE switches and socket outlets are enriched due to their simplicity of technical solutions and very simple installation.*

*Products are made by modern technological process and with high quality materials.*



 **ALING-CONEL**

DIZAJN OBLIKUJE NAŠ SVET

## PRESTIGE LINE

DESIGN SHAPES OUR WORLD



Dizajn i boje PRESTIGE LINE programa  
savršeno se uklapaju u vaše enterijere.

*Design and colours of PRESTIGE LINE  
perfectly match with your interiors.*

VRLO JEDNOSTAVAN - VEOMA IZRAŽAJAN - KLASIČAN  
VERY SIMPLE - VERY EXPRESSIVE - CLASICAL

# PRESTIGE LINE

## TEHNIČKE PREDNOSTI TECHNICAL ADVANTAGES

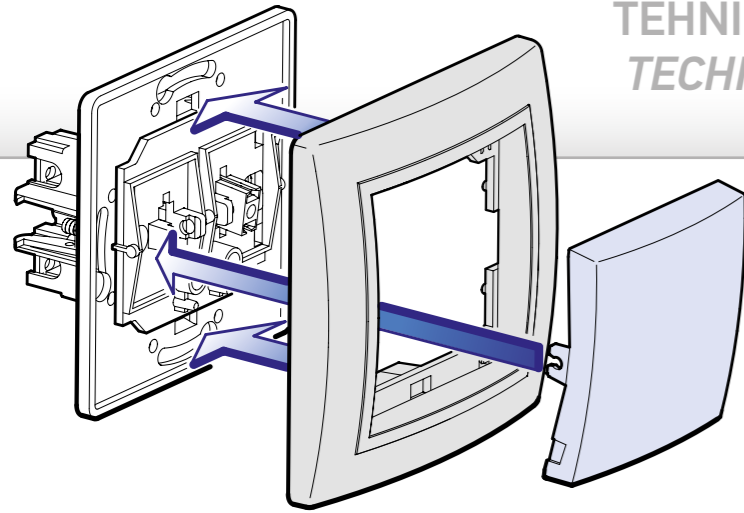

Masku i taster sklopke postavljamo i skidamo veoma jednostavno. Ova kombinacija će Vam i pored jednostavnosti obezbediti dugotrajan i pouzdan rad.  
*Installation of decorative cover frame and switch button is very simple and easy. Beside simplicity, this combination is providing a long and reliable usage.*

### BEZVIJČANA MONTAŽA SCREWLESS INSTALLATION

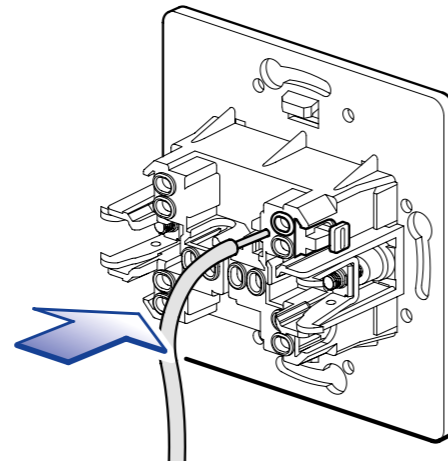

Bezvičajni kontakti omogućuju pouzdanu i brzu montažu do dva provodnika preseka 2,5mm<sup>2</sup>, bez upotrebe alata za stezanje.

*Screwless contacts are allowing safe and fast installation up to two conductors with diameter 2,5mm<sup>2</sup>, without screwdriver.*

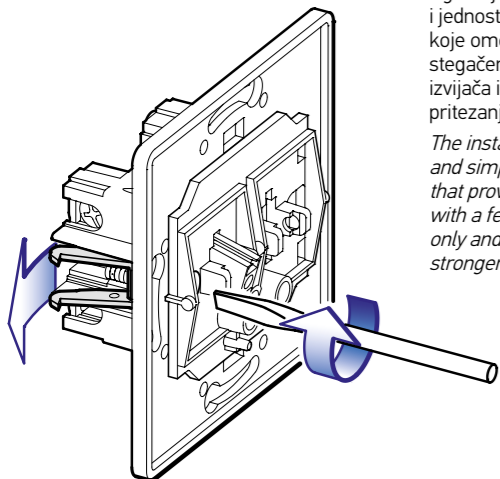

Ugradnja pomoću stegača je brza i jednostavna zahvaljujući rešenju koje omogućava pritezanje stegačem sa vrlo malo okretaja izvijača i bez potrebe jačeg pritezanja vijka.

*The installation by clamps is quick and simple thanks to the solution that provides tightening by clamps with a few screwdriver turnings only and without any necessity for stronger screw tightening.*

### VIJČANA MONTAŽA INSTALLATION WITH SCREWS

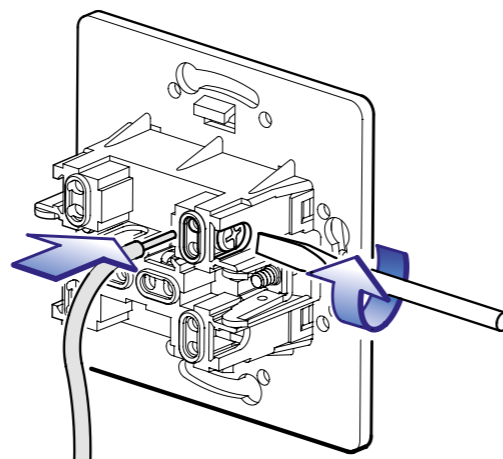

Pritezanje provodnika obezbedeno je pouzdanom i sigurnom vijčanom vezom za provodnike preseka do 4 mm<sup>2</sup>. Priključivanje provodnika je veoma brzo jer je obezbedeno njegovo postavljanje bez mogućnosti isklizavanja tokom pritezanja.

*The tightening of conductors is provided by the reliable and safe screw joint for the conductors section to 4 mm<sup>2</sup>. The connecting of conductors is very quick as their setting up is secured without any possibility of slipping out during tightening.*

Plastična priključnica je izrađena tako da zauzima veoma malo prostora u montažnoj kutiji čime se montaža pojednostavljuje zbog većeg prostora za smeštaj provodnika. Priključivanje provodnika je veoma brzo jer je obezbedeno njegovo postavljanje bez mogućnosti isklizavanja tokom pritezanja.

*Socket outlet is made to take a very little space in installation box. Installation is simple because of enough space for conductors. Connecting of wires is fast since there is no possibility of slipping out when tightening.*

# PRESTIGE LINE

## BOJE PREDNJIH ELEMENATA FRONT ELEMENTS COLORS

art.605.X X X

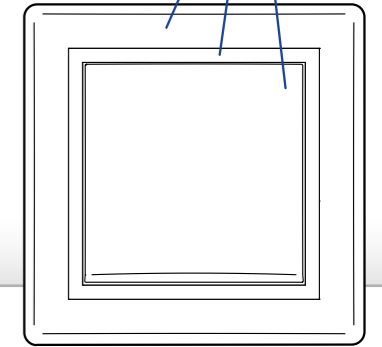

Mogućnosti kombinacija više boja date su trocifrenom šifrom proizvoda (za kompletne proizvode) ili jednocifrenom šifrom (za mehanizme bez maske i međurama, maske i međuramove) u zavisnosti od elementa:

**prva cifra** - šifra boje maske

**druga cifra** - šifra boje međurama

**treća cifra** - šifra boje središnjeg dela (taster, blok)

Kod jednocifrenog označavanja šifra predstavlja boju jednog elementa (taster, blok, maska, međuram).

Standardno se izrađuju boje:

*The possibility of colors combination is given by three-digit code of product (for the complete products) or one-digit code (for mechanisms without mask and interframe, masks and interframes) depending on element:*

**first digit** - code of mask color

**second digit** - code of interframe color

**third digit** - code of middle part color (push-button, block)

*One digit code represents the color of one element (button, block, mask, inter-frame)*

*The standard colors are:*

**x = 0**

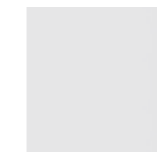

Bela  
White  
RAL 9003

**x = 1**



Siva  
Grey  
RAL 7035

**x = 2**

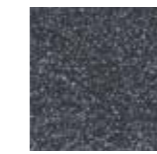

Grafit sa metalik efektom  
Graphite with metallic effect  
RAL 7021

**x = 3**



Bordo  
Dark red  
RAL 3004

**x = 9**



Krem  
Beige  
RAL 1013

**x = S**



Srebrna  
Silver



**00**  
Bela maska sa imitacijom međurama  
White frame with interframe imitation



**000**  
Bela  
White



**220**  
Grafit, grafit, bela  
Graphite, graphite, white



**212**  
Grafit, siva, grafit  
Graphite, grey, graphite



**330**  
Bordo, bordo, bela  
Dark red, dark red, white



**332**  
Bordo, bordo, grafit  
Dark red, dark red, graphite



**999**  
Krem  
Beige



**S2S**  
Srebrna, grafit, srebrna  
Silver, graphite, silver

STANDARDNE BOJE  
**PRESTIGE LINE**  
 STANDARD COLORS



Bela  
 White



Srebrna, grafit, srebrna  
 Silver, graphite, silver



Krem  
 Beige



Grafit, grafit, bela  
 Graphite, graphite, white



Grafit, siva, grafit  
 Graphite, grey, graphite



Bordo, bordo, bela  
 Dark red, dark red, white



Bordo, bordo, grafit  
 Dark red, dark red, graphite



# PRESTIGE LINE

## SKLOPKE SWITCHES

- Usaglašeno sa IEC 60669-1,
- Ugradnja u zid u montažnu kutiju Ø60 pomoću stegača ili vijaka
- Complied with IEC 60669-1,
- Wall mounted into the installation box Ø60 by clamps or screws

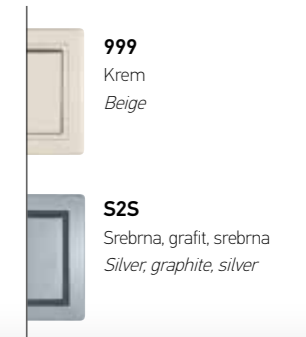
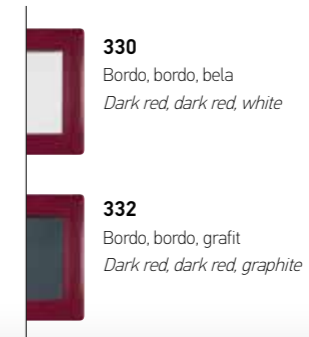

**605.xxx**  
Sklopka jednapolna 10AX/250V~  
*Single-pole switch 10AX/250V~*



**608.xxx**  
Sklopka ukrсна 10AX/250V~  
*Cross-switch 10AX/250V~*



**625.xxx**  
Sklopka jednapolna sa indikacijom 10AX/250V~  
*Single-pole switch with indication 10AX/250V~*

- Indikacija svetli kada je sklopka isključena
- *Indication turns on when the switch is off*



**628.xxx**  
Sklopka ukrсна sa indikacijom 10AX/250V~  
*Cross switch with indication 10AX/250V~*

- Indikacija svetli kada je strujno kolo otvoreno
- *Indication turns on when the circuit is open*



**6052.xxx**  
Sklopka dvopolna 10AX/250V~  
*Double-pole switch 10AX/250V~*



**609.xxx**  
Taster sklopka za svetlo bez indikacije 10AX/250V~  
*Light push-button switch without indication 10AX/250V~*



**626.xxx**  
Sklopka serijska sa indikacijom 10AX/250V~  
*Serial switch with indication 10AX/250V~*

- Indikacija svetli kada je sklopka isključena
- *Indication turns on when the switch is off*



**619.xxx**  
Sklopka jednapolna sa indikacijom 16AX/250V~  
*Single-pole switch with indication 16AX/250V~*

- Indikacija svetli kada je sklopka isključena
- *Indication turns on when the switch is off*



**606.xxx**  
Sklopka serijska 10AX/250V~  
*Serial switch 10AX/250V~*



**6091.xxx**  
Taster sklopka za svetlo sa indikacijom 10AX/250V~  
*Light push-button switch with indication 10AX/250V~*

- Indikacija svetli kada je sklopka isključena
- *Indication turns on when the switch is off*



**627.xxx**  
Sklopka naizmjenična sa indikacijom 10AX/250V~  
*Alternative switch with indication 10AX/250V~*

- Indikacija svetli kada je strujno kolo otvoreno
- *Indication turns on when the circuit is open*



**6191.xxx**  
Sklopka jednapolna indikatorska 16AX/250V~  
*Single-pole switch with indication 16AX/250V~*

- Indikacija svetli kada je sklopka uključena
- *Indication turns on when the switch is on*



**607.xxx**  
Sklopka naizmjenična 10AX/250V~  
*Alternative switch 10AX/250V~*



**610.xxx**  
Taster sklopka za zvono bez indikacije 10AX/250V~  
*Bell push-button switch without indication 10AX/250V~*



**6072.xxx**  
Sklopka naizmjenična dvostruka 10AX/250V~  
*Alternative switch double 10AX/250V~*



**6101.xxx**  
Taster sklopka za zvono sa indikacijom 10AX/250V~  
*Bell push-button switch with indication 10AX/250V~*

- Indikacija svetli kada je sklopka isključena
- *Indication turns on when the switch is off*

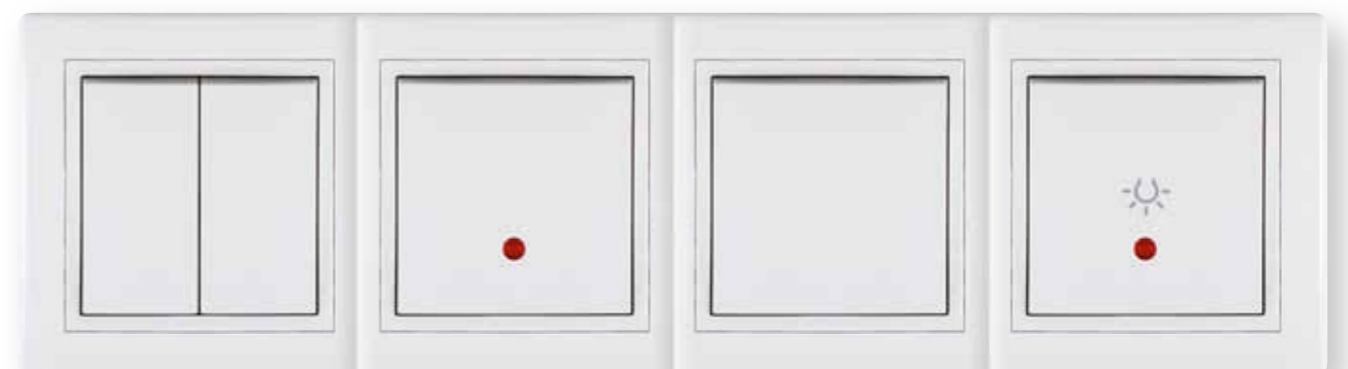

# PRESTIGE LINE

## ELEKTRONIKA ELECTRONICS



### 617.xxx

Regulator jačine svetlosti sa naizmeničnom sklopkom 40-400VA, 230V~/50Hz

*Dimmer with alternative switch 40-400VA, 230V~/50Hz*

- Za sijalice sa užarenim vlaknom i halogene sijalice sa standardnim transformatorom,
- Usaglašeno sa IEC 60669-2-1
- Ugradnja u zid u montažnu kutiju Ø60 pomoću stegača ili vijaka

- *For incandescent filament lamps and halogen lamps with standard transformer*
- *Complied with IEC 60669-2-1*
- *Wall mounted into the installation box Ø60 by clamps or screws*



### 6173.xxx

Regulator jačine svetlosti sa rotacionom jednopolnom sklopkom 40-400VA, 230V~/50Hz

*Dimmer with rotary single-pole switch 40-400VA, 230V~/50Hz*

- Za sijalice sa užarenim vlaknom i halogene sijalice sa standardnim transformatorom,
- Usaglašeno sa IEC 60669-2-1
- Ugradnja u zid u montažnu kutiju Ø60 pomoću stegača ili vijaka

- *For incandescent filament lamps and halogen lamps with standard transformer*
- *Complied with IEC 60669-2-1*
- *Wall mounted into the installation box Ø60 by clamps or screws*

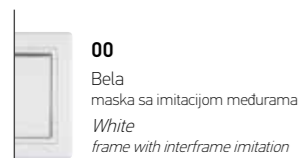

**00**

Bela maska sa imitacijom međurama  
*White frame with interframe imitation*

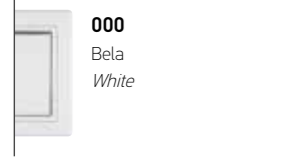

**000**

Bela  
*White*



**220**

Grafit, grafit, bela  
*Graphite, graphite, white*



**212**

Grafit, siva, grafit  
*Graphite, grey, graphite*

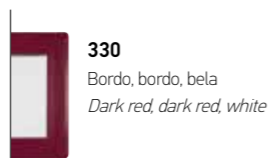

**330**

Bordo, bordo, bela  
*Dark red, dark red, white*



**332**

Bordo, bordo, grafit  
*Dark red, dark red, graphite*



**999**

Krem  
*Beige*



**S2S**

Srebrna, grafit, srebrna  
*Silver, graphite, silver*

# PRESTIGE LINE

## PRIKLJUČNICE SOCKET OUTLETS

- Usaglašeno sa IEC 60884-1,
- Ugradnja u zid u montažnu kutiju Ø60 pomoću stegača ili vijaka
- *Complied with IEC 60884-1,*
- *Wall mounted into the installation box Ø60 by clamps or screws*



### 600.xxx

Priključnica dvopolna 16A/250V- sa porcelanskim jezgrom

*Double-pole socket outlet 16A/250V- with porcelain insert*



### 603.xxx

Priključnica dvopolna sa poklopcem 16A/250V- sa porcelanskim jezgrom

*Double-pole socket outlet with cover 16A/250V- with porcelain insert*



### 601.xxx

Priključnica dvopolna 16A/250V- sa porcelanskim jezgrom i zaštitom od dodira

*Double-pole socket outlet 16A/250V- with porcelain insert and touch protection*



### 633.xxx

Priključnica dvopolna sa poklopcem 16A/250V- sa polikarbonatskim jezgrom

*Double-pole socket outlet with cover 16A/250V- with polycarbonate insert*



### 630.xxx

Priključnica dvopolna 16A/250V- sa polikarbonatskim jezgrom

*Double-pole socket outlet 16A/250V- with polycarbonate insert*



### 640.x

Kutija za stalni priključak 5x2,5mm<sup>2</sup> za u zid 440V-

*Junction box for continuous connection 5x2,2mm<sup>2</sup> for into the wall 440V-*



### 604.xx

Priključnica dvopolna dvostruka 16A/250V- sa polikarbonatskim jezgrom

*Double-pole socket outlet 16A/250V- double with polycarbonate insert*

- Nema mogućnost ugradnje u višestruke maske
- *No possibility of mounting into multiple masks*



### 602.xx

Priključnica tropolna 16A/440V- sa porcelanskim jezgrom

*Tripolar socket outlet 16A/440V- with porcelain insert*

- Ugradnja u zid u montažnu kutiju Ø70 pomoću vijaka
- *Wall mounted into the installation box Ø70 by screws*



## PRESTIGE LINE

### PRIKLJUČNICE SOCKET OUTLETS

- Usaglašeno sa IEC 60884-1, NF C 61-314,
- Ugradnja u zid u montažnu kutiju Ø60 pomoću stegača ili vijaka
- Complied with IEC 60884-1, NF C 61-314,
- Wall mounted into the installation box Ø60 by clamps or screws



#### 635.xxx

Priključnica dvopolna 16A/250V~ Francuski standard  
*Double-pole socket outlet 16A/250V~ French standard*



#### 6350.xxx

Priključnica dvopolna 16A/250V~ sa zaštitom od dodira Francuski standard  
*Double-pole socket outlet 16A/250V~ with touch protection French standard*



#### 6045.xx

Priključnica dvopolna dvostruka 16A/250V~ sa polikarbonatskim jezgrom Francuski standard  
*Double-pole socket outlet 16A/250V~ double with polycarbonate insert French standard*

- Nema mogućnost ugradnje u višestruke maske
- No possibility of mounting into multiple masks

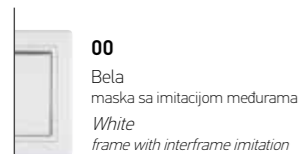

**00**  
Bela maska sa imitacijom međurama  
*White frame with interframe imitation*



**000**  
Bela maska  
*White*



**220**  
Grafit, grafit, bela maska  
*Graphite, graphite, white*



**212**  
Grafit, siva, grafit maska  
*Graphite, grey, graphite*

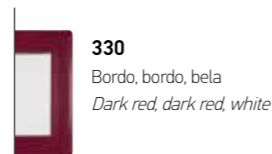

**330**  
Bordo, bordo, bela maska  
*Dark red, dark red, white*

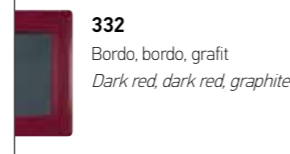

**332**  
Bordo, bordo, grafit maska  
*Dark red, dark red, graphite*

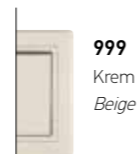

**999**  
Krem maska  
*Beige*



**S2S**  
Srebrna, grafit, srebrna maska  
*Silver, graphite, silver*

## PRESTIGE LINE

### KOMUNIKACIJE COMMUNICATIONS

- Usaglašeno sa IEC 60603-7,
- Ugradnja u zid u montažnu kutiju Ø60 pomoću stegača ili vijaka
- Complied with IEC 60603-7,
- Wall mounted into the installation box Ø60 by clamps or screws



#### 611.xxx

Priključnica telefonska dvostruka RJ12 6/2 sa dve odvojene linije  
*Double telephone socket RJ12 6/2 with two separate lines*



#### 613.xxx

Priključnica telefonska dvostruka RJ12 6/4 sa dve spojene linije  
*Double telephone socket RJ12 6/4 with two connected lines*



#### 6131.xxx

Priključnica telefonska dvostruka sa Keystone modulima RJ 12 6/6 Cat 3  
*Double telephone socket with Keystone modules RJ12 6/6 Cat 3*

- Montaža provodnika bez upotrebe alata
- *Tooles conducting wire installation*



#### 614.xxx

Priključnica komunikacijska sa Keystone modulima dvostruka RJ45 Cat5e UTP  
*Data socket double with Keystone modules RJ45 Cat5e UTP*

- Montaža provodnika bez upotrebe alata
- Spajanje prema TIA/EIA-568A ili 568B standardu za raspored parica
- *Tooles conducting wire installation*
- *Wiring according to TIA/EIA-568A or 568B standard for the arrangement of pairs*



#### 614S.xxx

Priključnica komunikacijska sa Keystone modulima dvostruka RJ45 Cat5e FTP  
*Data socket double with Keystone modules RJ45 Cat5e FTP (shielded)*

- Montaža provodnika bez upotrebe alata
- Spajanje prema TIA/EIA-568A ili 568B standardu za raspored parica
- *Tooles conducting wire installation*
- *Wiring according to TIA/EIA-568A or 568B standard for the arrangement of pairs*



#### 615.xxx

Priključnica komunikacijska sa Keystone modulima dvostruka RJ45 Cat6 UTP  
*Data socket double with Keystone modules RJ45 Cat6 UTP*

- Montaža provodnika bez upotrebe alata
- Spajanje prema TIA/EIA-568A ili 568B standardu za raspored parica
- *Tooles conducting wire installation*
- *Wiring according to TIA/EIA-568A or 568B standard for the arrangement of pairs*



#### 615S.xxx

Priključnica komunikacijska sa Keystone modulima dvostruka RJ45 Cat6 FTP  
*Data socket double with Keystone modules RJ45 Cat6 FTP (shielded)*

- Montaža provodnika bez upotrebe alata
- Spajanje prema TIA/EIA-568A ili 568B standardu za raspored parica
- *Tooles conducting wire installation*
- *Wiring according to TIA/EIA-568A or 568B standard for the arrangement of pairs*



## PRESTIGE LINE

### KOMUNIKACIJE COMMUNICATIONS

- Usaglašeno sa IEC 60169-2,
- Ugradnja u zid u montažnu kutiju Ø60 pomoću stegača ili vijaka
- Complied with IEC 60169-2,
- Wall mounted into the installation box Ø60 by clamps or screws

## PRESTIGE LINE

### MEHANIZMI BEZ MASKE I MEĐURAMA MECHANISMS WITHOUT COVER FRAME AND INTERFRAME



#### 612L.xxx

Priključnica antenska TV završna za individualne sisteme

*TV aerial socket for individual systems*

- Muški konektor,
- Odvodno slabljenje signala <1 dB
- Male connector,
- Connection attenuation <1 dB



#### 612P.xxx

Priključnica antenska TV/FM prolazna TV/FM aerial socket transient

- Muški konektor TV, ženski konektor FM,
- Prolazno slabljenje 4 dB, odvodno 6 dB, sprega TV/FM >20 dB
- Male connector TV, female connector FM,
- Throughpass attenuation 4 dB, connection atten. 6 dB, coupling TV/FM >20 dB



#### 612Z.xxx

Priključnica antenska TV/FM završna TV/FM aerial socket terminal

- Muški konektor TV, ženski konektor FM,
- Odvodno slabljenje <2 dB, sprega TV/FM >20 dB
- Male connector TV, female connector FM,
- Connection attenuation <2 dB, coupling attenuation TV/FM >20 dB



#### 612S.xxx

Priključnica antenska TV/FM/SAT završna TV/FM/SAT aerial socket terminal

- Muški konektor TV, ženski konektor FM,
- SAT konektor IEC 60169-24 (F tip),
- Odvodno slabljenje <2 dB, sprega TV/FM >20 dB
- Male connector TV, male connector FM,
- SAT connector IEC 60169-24 (F type),
- Connection attenuation <2 dB, coupling attenuation TV/FM >20 dB

# PRESTIGE LINE



Za ugradnju u višestruke maske proizvodi PRESTIGE LINE isporučuju se bez pripadajuće maske i međurama, čime je omogućeno da korisnik sam kombinuje boje i grupisanje komponenti. Uz svaki mehanizam isporučuje se taster ili blok u standardnim bojama.

*For the installation into the multiple masks, the products of PRESTIGE LINE are supplied without the pertaining frame and interframe thus enabling the user to make the combination of colours and grouping of components. Each mechanism is supplied with button or the block in standard colours.*

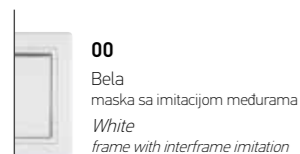

**00**

Bela maska sa imitacijom međurama  
White frame with interframe imitation



**000**

Bela  
White



**220**

Grafit, grafit, bela  
Graphite, graphite, white



**212**

Grafit, siva, grafit  
Graphite, grey, graphite

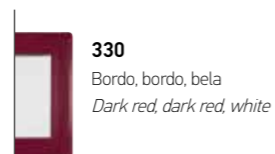

**330**

Bordo, bordo, bela  
Dark red, dark red, white

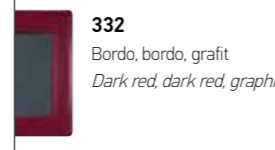

**332**

Bordo, bordo, grafit  
Dark red, dark red, graphite



**999**

Krem  
Beige



**S2S**

Srebrna, grafit, srebrna  
Silver, graphite, silver

- Usaglašeno sa IEC 60669-1,
- Ugradnja u zid u montažnu kutiju Ø60 pomoću stegača ili vijaka

- Complied with IEC 60669-1,
- Wall mounted into the installation box Ø60 by clamps or screws



### 6005.x

Sklopka jednopolna  
10AX/250V~  
*Single-pole switch  
10AX/250V~*



### 6009.x

Taster sklopka za svetlo  
bez indikacije  
10AX/250V~  
*Light push-button switch  
without indication  
10AX/250V~*



### 6027.x

Sklopka naizmenična  
sa indikacijom 10AX/250V~  
*Alternative switch  
with indication 10AX/250V~*

- Indikacija svetli kada je strujno kolo otvoreno
- *Indication turns on when the circuit is open*



### 6000.x

Priključnica dvopolna 16A/250V~  
sa porcelanskim jezgrom  
*Double-pole socket outlet  
16A/250V~ with porcelain insert*



### 60052.x

Sklopka dvopolna  
10AX/250V~  
*Double-pole switch  
10AX/250V~*



### 60091.x

Taster sklopka za svetlo  
sa indikacijom 10AX/250V~  
*Light push-button switch  
with indication 10AX/250V~*

- Indikacija svetli kada je sklopka isključena
- *Indication turns on when the switch is off*

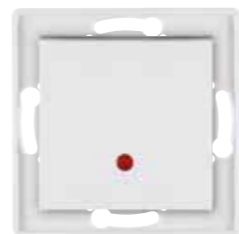

### 6028.x

Sklopka ukrсна  
sa indikacijom 10AX/250V~  
*Cross switch  
with indication 10AX/250V~*

- Indikacija svetli kada je strujno kolo otvoreno
- *Indication turns on when the circuit is open*



### 6001.x

Priključnica dvopolna 16A/250V~  
sa porcelanskim jezgrom  
i zaštitom od dodira  
*Double-pole socket outlet  
16A/250V~ with porcelain insert  
and touch protection*



### 6006.x

Sklopka serijska  
10AX/250V~  
*Serial switch  
10AX/250V~*



### 6010.x

Taster sklopka za zvono  
bez indikacije  
10AX/250V~  
*Bell push-button switch  
without indication  
10AX/250V~*

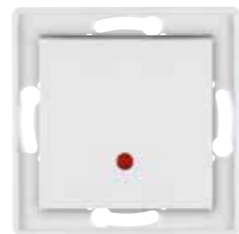

### 6019.x

Sklopka jednopolna  
sa indikacijom 16AX/250V~  
*Single-pole switch  
with indication 16AX/250V~*

- Indikacija svetli kada je strujno kolo otvoreno
- *Indication turns on when the circuit is open*



### 6030.x

Priključnica dvopolna 16A/250V~  
sa polikarbonatskim jezgrom  
*Double-pole socket outlet 16A/250V~  
with polycarbonate insert*



### 6007.x

Sklopka naizmenična  
10AX/250V~  
*Alternative switch  
10AX/250V~*



### 60101.x

Taster sklopka za zvono  
sa indikacijom 10AX/250V~  
*Bell push-button switch  
with indication 10AX/250V~*

- Indikacija svetli kada je sklopka isključena
- *Indication turns on when the switch is off*



### 60191.x

Sklopka jednopolna  
indikatorska 16AX/250V~  
*Single-pole switch  
with indication 16AX/250V~*

- Indikacija svetli kada je sklopka uključena
- *Indication turns on when the switch is on*

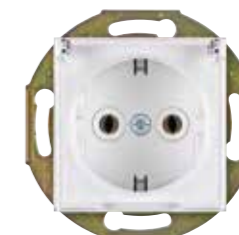

### 6003.x

Priključnica dvopolna  
sa poklopcem 16A/250V~  
sa porcelanskim jezgrom  
*Double-pole socket outlet  
with cover 16A/250V~  
with porcelain insert*



### 60072.x

Sklopka naizmenična  
dvostruka 10AX/250V~  
*Alternative switch double  
10AX/250V~*



### 6025.x

Sklopka jednopolna  
sa indikacijom 10AX/250V~  
*Single-pole switch  
with indication 10AX/250V~*

- Indikacija svetli kada je sklopka isključena
- *Indication turns on when the switch is off*



### 6008.x

Sklopka ukrсна  
10AX/250V~  
*Cross-switch  
10AX/250V~*

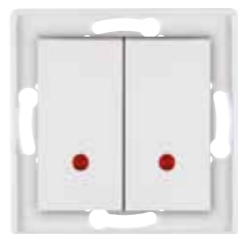

### 6026.x

Sklopka serijska  
sa indikacijom 10AX/250V~  
*Serial switch  
with indication 10AX/250V~*

- Indikacija svetli kada je sklopka isključena
- *Indication turns on when the switch is off*



### 6035.x

Priključnica dvopolna 16A/250V~  
Francuski standard  
*Double-pole socket outlet 16A/250V~  
French standard*

- Usaglašeno sa NF C 61-314
- *Complied with NF C 61-314*



### 60350.x

Priključnica dvopolna 16A/250V~  
sa zaštitom od dodira  
Francuski standard  
*Double-pole socket outlet 16A/250V~  
with touch protection  
French standard*

- Usaglašeno sa NF C 61-314
- *Complied with NF C 61-314*

- Usaglašeno sa IEC 60669-2-1
- Ugradnja u zid u montažnu kutiju Ø60 pomoću stegača ili vijaka

- Complied with IEC 60669-2-1
- Wall mounted into the installation box Ø60 by clamps or screws

- Usaglašeno sa IEC 60603-7,
- Ugradnja u zid u montažnu kutiju Ø60 pomoću stegača ili vijaka

- Complied with IEC 60603-7,
- Wall mounted into the installation box Ø60 by clamps or screws

- Usaglašeno sa IEC 60169-2,
- Ugradnja u zid u montažnu kutiju Ø60 pomoću stegača ili vijaka

- Complied with IEC 60169-2,
- Wall mounted into the installation box Ø60 by clamps or screws



### 6017.x

Regulator jačine svetlosti sa naizmeničnom sklopkom 40-400VA, 230V~/50Hz

*Dimmer with alternative switch 40-400VA, 230V~/50Hz*

- Za sijalice sa užarenim vlaknom i halogene sijalice sa standardnim transformatorom,
- For incandescent filament lamps and halogen lamps with standard transformer



### 6011.x

Priključnica telefonska dvostruka RJ12 6/2 sa dve odvojene linije

*Double telephone socket RJ12 6/2 with two separate lines*



### 6014.x

Priključnica komunikacijska sa Keystone modulima dvostruka RJ45 Cat5e UTP

*Data socket double with Keystone modules RJ45 Cat5e UTP*



### 6012I.x

Priključnica antenska TV završna za individualne sisteme

*TV aerial socket for individual systems*

- Muški konektor,
- Odvodno slabljenje signala <1 dB
- Male connector,
- Connection attenuation <1 dB



### 60173.x

Regulator jačine svetlosti sa rotacionom jednopolnom sklopkom 40-400VA, 230V~/50Hz

*Dimmer with rotary single-pole switch 40-400VA, 230V~/50Hz*

- Za sijalice sa užarenim vlaknom i halogene sijalice sa standardnim transformatorom,
- For incandescent filament lamps and halogen lamps with standard transformer



### 6013.x

Priključnica telefonska dvostruka RJ12 6/4 sa dve spojene linije

*Double telephone socket RJ12 6/4 with two connected lines*



### 6014S.x

Priključnica komunikacijska sa Keystone modulima dvostruka RJ45 Cat5e FTP

*Data socket double with Keystone modules RJ45 Cat5e FTP*



### 6012Z.x

Priključnica antenska TV/FM završna za individualne sisteme

- Muški konektor TV, ženski konektor FM,
- Odvodno slabljenje <2 dB, sprega TV/FM >20 dB
- Male connector TV, female connector FM,
- Connection attenuation <2 dB, coupling attenuation TV/FM >20 dB



### 60131.x

Priključnica telefonska dvostruka sa Keystone modulima RJ 12 6/6 Cat 3

*Double telephone socket with Keystone modules RJ12 6/6 Cat 3*

- Montaža provodnika bez upotrebe alata
- Toolless conducting wire installation



### 6015.x

Priključnica komunikacijska sa Keystone modulima dvostruka RJ45 Cat6 UTP

*Data socket double with Keystone modules RJ45 Cat6 UTP*



### 6012P.x

Priključnica antenska TV/FM prolazna za individualne sisteme

- Muški konektor TV, ženski konektor FM,
- Prolazno slabljenje 4 dB, odvodno 6 dB, sprega TV/FM >20 dB
- Male connector TV, female connector FM,
- Throughpass attenuation 4 dB, connection atten. 6 dB, coupling TV/FM >20 dB



### 6015S.x

Priključnica komunikacijska sa Keystone modulima dvostruka RJ45 Cat6 FTP

*Data socket double with Keystone modules RJ45 Cat6 FTP*

- Montaža provodnika bez upotrebe alata
- Spajanje prema TIA/EIA-568A ili 568B standardu za raspored parica
- Toolless conducting wire installation
- Wiring according to TIA/EIA-568A or 568B standard for the arrangement of pairs



### 6012S.x

Priključnica antenska TV/FM/SAT završna za individualne sisteme

*TV/FM/SAT aerial socket terminal*

- Muški konektor TV, ženski konektor FM,
- SAT konektor IEC 60169-24 (F tip),
- Odvodno slabljenje <2 dB, sprega TV/FM >20 dB
- Male connector TV, male connector FM,
- SAT connector IEC 60169-24 (F type),
- Connection attenuation <2 dB, coupling attenuation TV/FM >20 dB

	Bela White	<b>x = 0</b>
	Grafit Graphite	<b>x = 2</b>
	Bordo Dark red	<b>x = 3</b>
	Krem Beige	<b>x = 9</b>
	Silver Silver	<b>x = S</b>

# PRESTIGE LINE

## MASKE I MEĐURAMOVI COVER FRAMES AND INTERFRAMES

- Usaglašeno sa IEC 60669-1 i IEC 60884-1,
- Za ugradnju na PRESTIGE LINE mehanizme ugrađene u zid u nizajuće dozne za višestruke maske (osno rastojanje 71 mm)
- Complied with IEC 60669-1 and IEC 60884-1,
- For mounting onto PRESTIGE LINE mechanisms wall mounted in a sequence of boxes for multiple masks (axial distance 71 mm)

Bela  
White **x = 0**

Grafit  
Graphite **x = 2**

Krem  
Beige **x = 9**

Bordo  
Dark red **x = 3**

Silver  
Silver **x = 5**



**6801.x**  
Maska jednostruka  
PRESTIGE LINE  
*One-gang frame  
PRESTIGE LINE*



**6701.x**  
Maska dvostruka  
PRESTIGE LINE  
horizontalna  
*Two-gang frame  
PRESTIGE LINE  
horizontal*

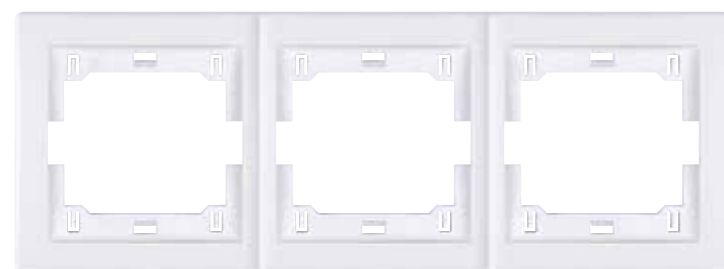

**6703.x**  
Maska trostruka  
PRESTIGE LINE  
horizontalna  
*Three-gang frame  
PRESTIGE LINE  
horizontal*



**6704.x**  
Maska četvorostruka  
PRESTIGE LINE  
horizontalna  
*Four-gang frame  
PRESTIGE LINE  
horizontal*



**6711.x**  
Maska dvostruka  
PRESTIGE LINE  
vertikalna  
*Two-gang frame  
PRESTIGE LINE  
vertical*



**6713.x**  
Maska trostruka  
PRESTIGE LINE  
vertikalna  
*Three-gang frame  
PRESTIGE LINE  
vertical*



**6714.x**  
Maska četvorostruka  
PRESTIGE LINE  
vertikalna  
*Four-gang frame  
PRESTIGE LINE  
vertical*



**6802.x**  
Međuram PRESTIGE LINE  
*Interframe PRESTIGE LINE*

- Usaglašeno sa IEC 60669-1 i IEC 60884-1,
- Za ugradnju na PRESTIGE LINE maske kao ukrasni element
- Complied with IEC 60669-1 and IEC 60884-1,
- For mounting onto PRESTIGE LINE frames, like decorative element

Beli	<b>6802.0</b>	White
Sivi	<b>6802.1</b>	Grey
Grafit	<b>6802.2</b>	Graphite
Bordo	<b>6802.3</b>	Dark red
Crveni	<b>6802.4</b>	Red
Svetlo plavi	<b>6802.5</b>	Light blue
Teget	<b>6802.6</b>	Navy-blue
Svetlo zeleni	<b>6802.7</b>	Light green
Žuti	<b>6802.8</b>	Yellow
Krem	<b>6802.9</b>	Beige
Roze	<b>6802.10</b>	Pink
Metalik srebrni	<b>6802.11</b>	Metallic silver
Zeleni	<b>6802.12</b>	Green

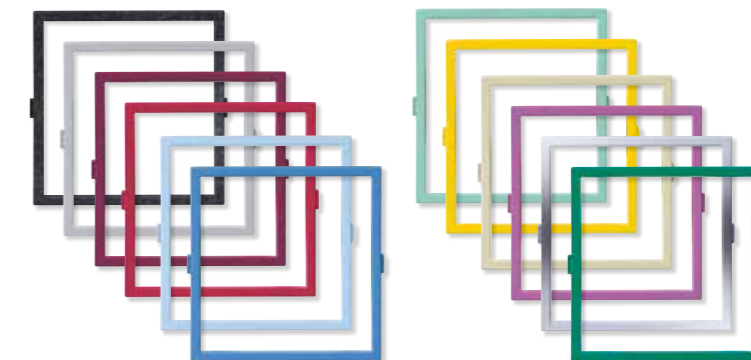



# PRESTIGE LINE

## ŠEME VEZIVANJA WIRING DIAGRAMS

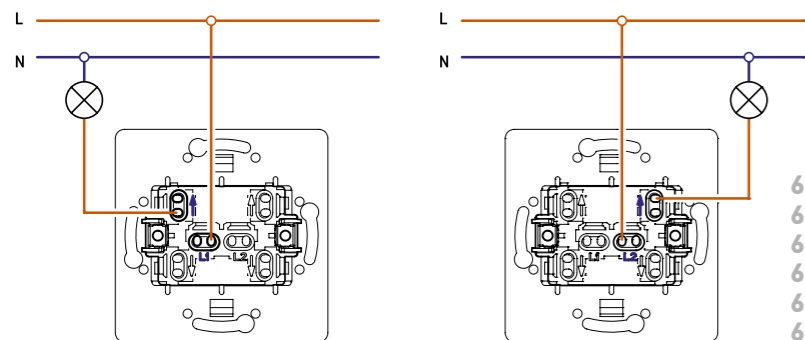

605  
6091  
610  
6101  
625  
619

Jednopolna sklopka ima dve izvedbe sklopanja (leva i desna) i u skladu s tim se povezuju priključni provodnici.  
*Single-pole switch is supplied in two wiring executions (left and right) and the conductors are connected accordingly.*

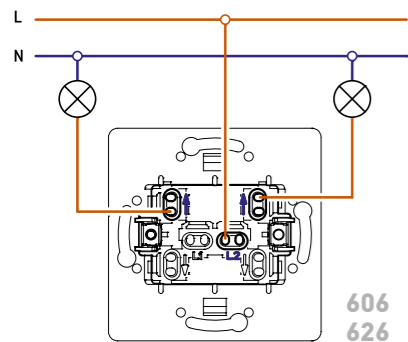

606  
626

Serijska sklopka  
*Serial switch*

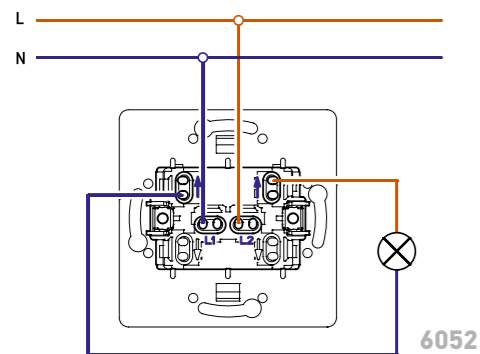

6052

Dvopolna sklopka  
*Double pole switch*

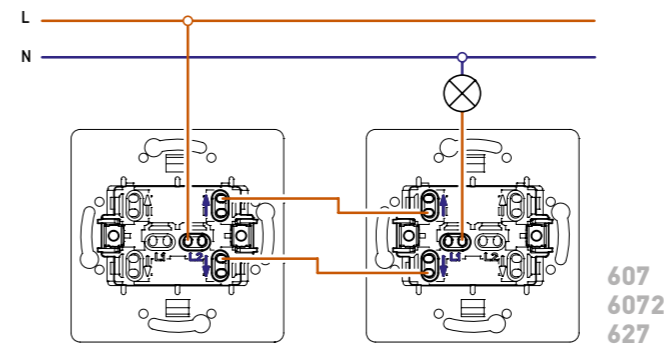

607  
6072  
627

Naizmjenična sklopka, dve izvedbe sklopanja (leva i desna)  
*Alternative switch, two wiring executions (left and right)*

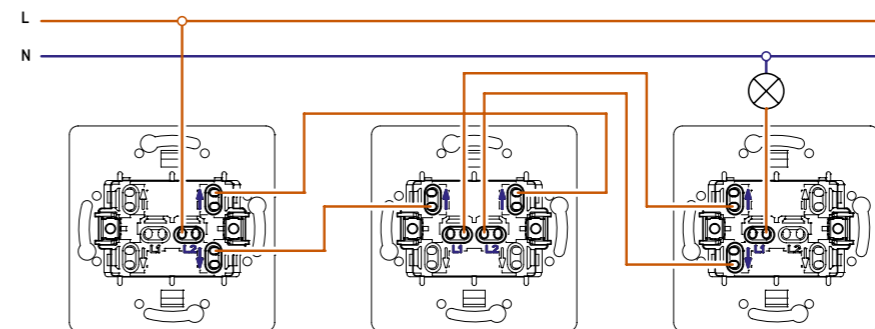
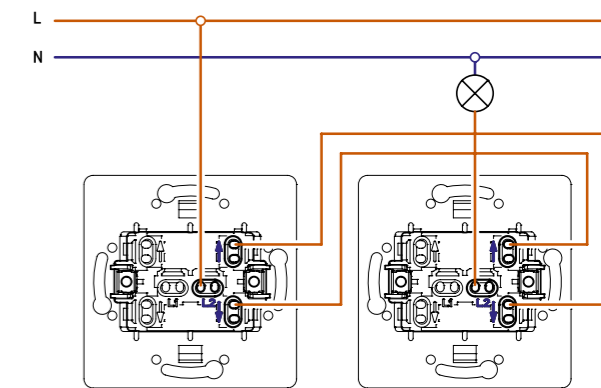

608  
628

Ukrsna sklopka se povezuje u kombinaciji sa naizmjeničnim sklopkama. Može se povezati neograničen broj ukrasnih sklopki u kombinaciji sa dve naizmjenične.

*Cross-switch is wired in combination with alternative switches. The unlimited number of cross switches may be wired in combination with two alternative switches.*

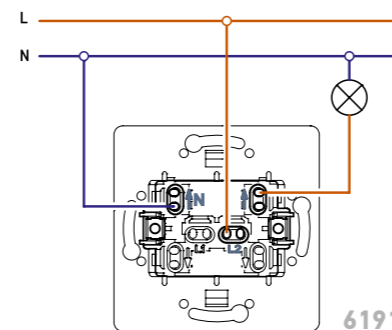

6191

Jednopolne indikatorske sklopke (indikacija svetli kada je sklopka uključena) za povezivanje zahtevaju multi provodnik  
*Single-pole indication switches (indication turns on when the switch is on) require neutral conductor to be wired.*

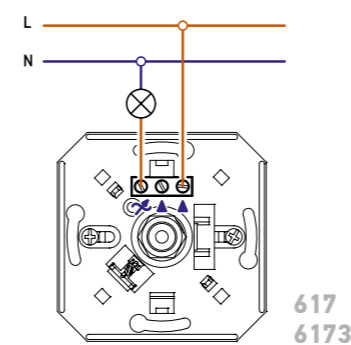

617  
6173

Povezivanje regulatora jačine svetlosti sa naizmjeničnom sklopkom kao jednopolne sklopke i regulatora sa rotacionom jednopolnom sklopkom.  
*Wiring of dimmer with alternative switch as a single-pole switch and the dimmer with rotary single-pole switch.*

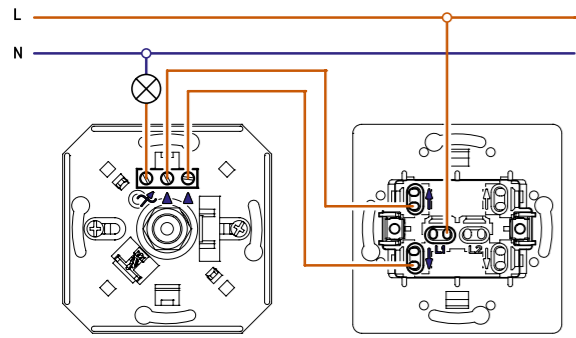

Regulator jačine svetlosti sa naizmničnom sklopkom može se povezivati i u kombinaciji sa naizmničnom sklopkom za regulaciju sa jednog mesta i uključivanje i isključivanje sa dva mesta. Međusobno povezivanje više regulatora nije moguće.

*Dimmer with alternative switch may be also wired in combination with alternative switch for the regulation from one place and switching on and off from two places. Inter-wiring of more regulators is not possible.*

617

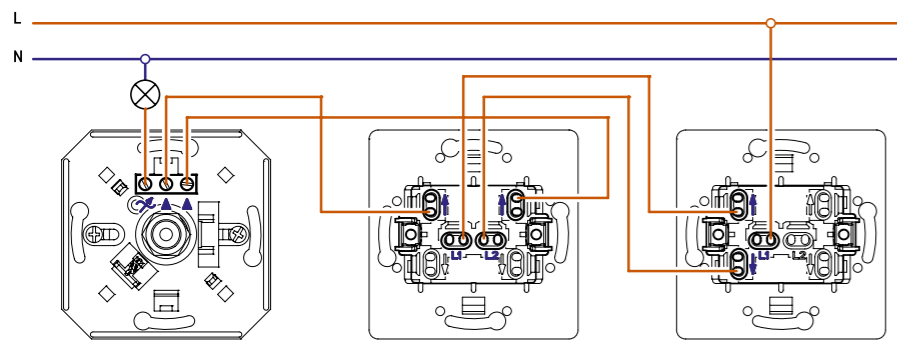

Kombinacijom regulatora sa naizmničnom sklopkom i ukrsne i naizmnične sklopke omogućava se uključivanje i isključivanje sa proizvoljan broj mesta.

*The combination of dimer with alternative switch and cross and alternative switch provides the switching on and off from the desirable number of places.*

617

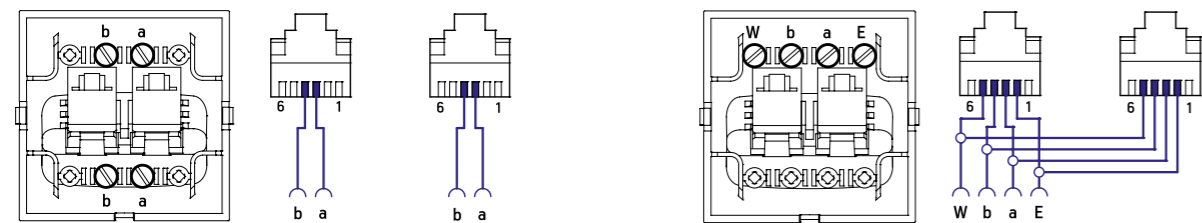

Telefonske priključnice sa standardnim RJ12 konektorima u saglasnosti sa IEC 60603-7 u kombinaciji 2 x 6/2 i 2 x 6/4 kontakta. Povezivanje se vrši prema priloženim šemama gde su kontakti a i b osnovna linija, a W i E kontakti druge parice za analogni terminal (prema internacionalnom standardu).

*Telephone sockets with standard RJ12 connectors in compliance with IEC 60603-7 in combination of 2 x 6/2 and 2 x 6/4 contacts. The wiring is carried out in accordance with wiring diagrams where the contacts a and b represent the basic line while W and E are the contacts of the second pair for analogue terminal (according to international standard).*

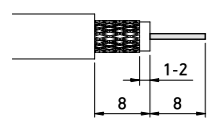

Pripremljen antenski kabal priključujemo pritezanjem u priključnu stezaljku i stezanjem oklopa kabla priteznom papučicom prema datim šemama.

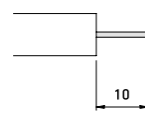

*Prepared aerial cable may be installed into terminal and shield tightened by tightening clamp according showed scheme.*

Antenski kabal za priključenje na antenske priključnice potrebno je pripremiti prema prikazanoj šemi da bi se postigao siguran kontakt, jednostavno postavljanje i onemogućio eventualni kratak spoj.

*For safe contact, simple installing and short-circuit disabling cable for aerial socket wiring must be prepared according showed scheme.*

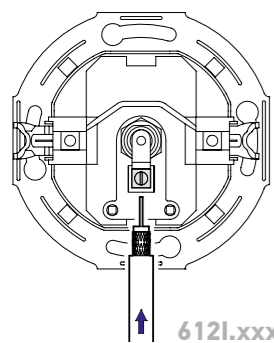

6121.xxx

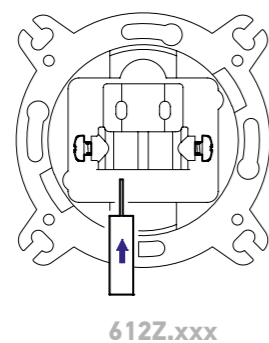

612Z.xxx

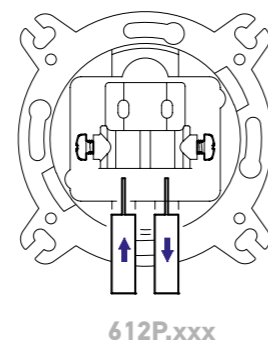

612P.xxx

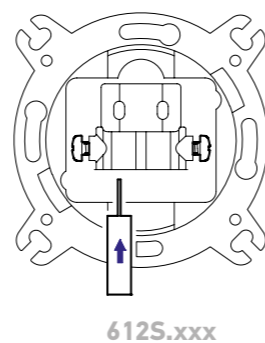

612S.xxx

## PRESTIGE LINE

### DIMENZIJE ZA UGRADNJU INSTALATION DIMENSIONS

- Osnova maske 80x80mm
- Cover frame base 80x80mm

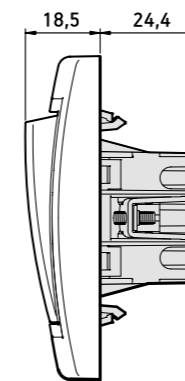

Sklopke  
Switches

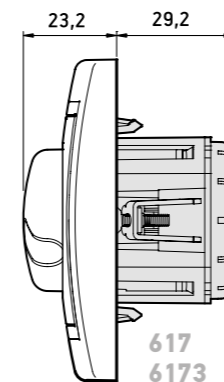

617  
6173

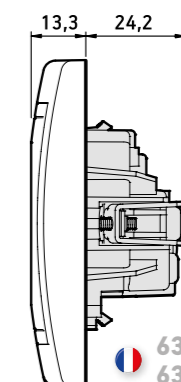

635  
6350

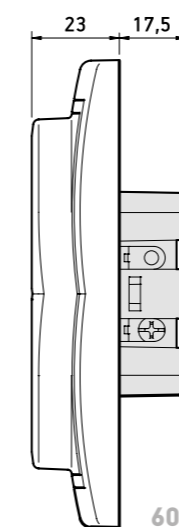

Osnova maske  
80x123mm  
Cover frame base  
80x123mm

604

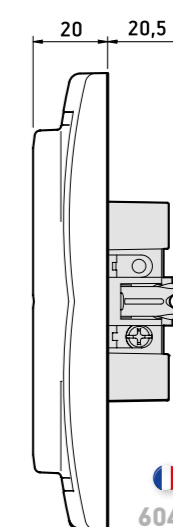

Osnova maske  
80x123mm  
Cover frame base  
80x123mm

6045

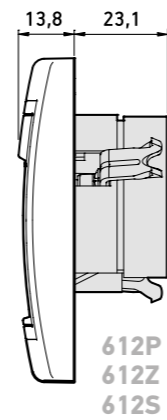
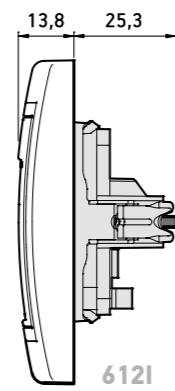
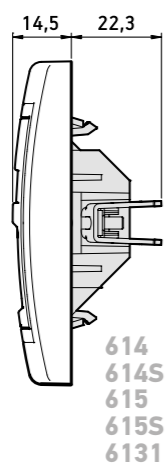
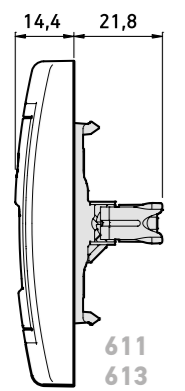
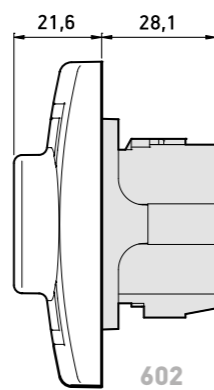
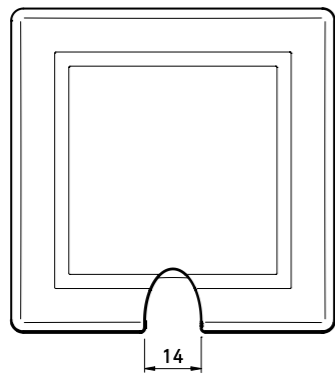
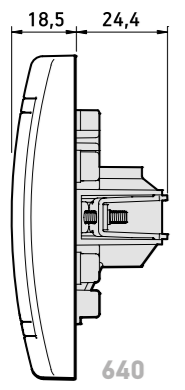
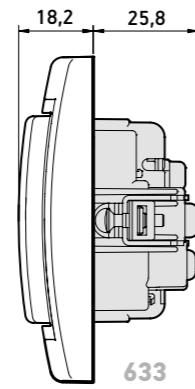
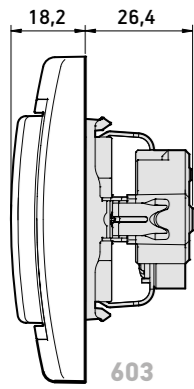
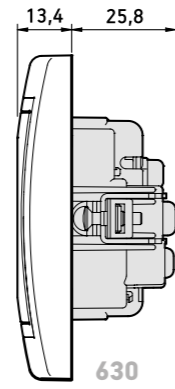
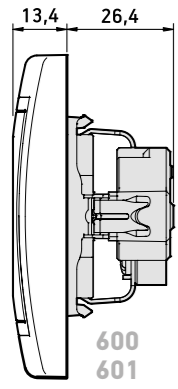

# PRESTIGE LINE

## TEHNIČKI CRTEŽI TECHNICAL DRAWINGS

- Osnova maske 80x80mm
- Cover frame base 80x80mm

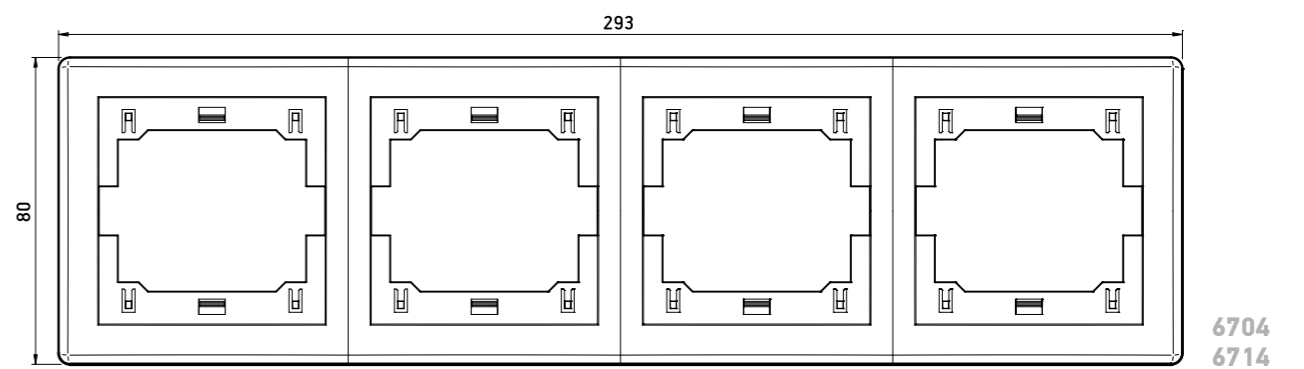
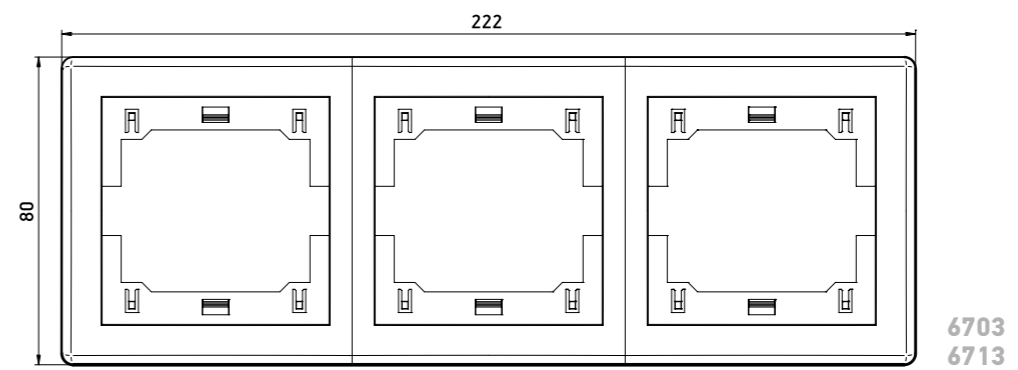
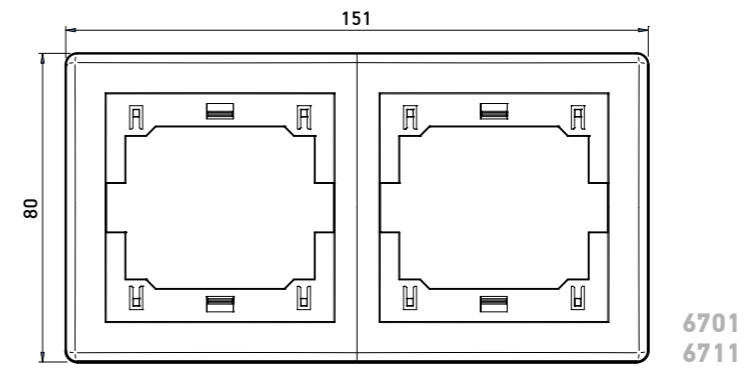
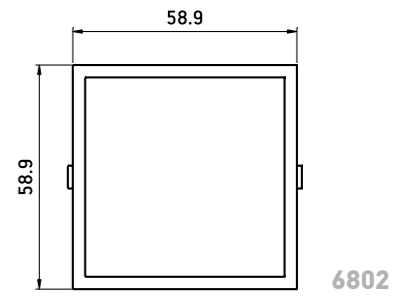
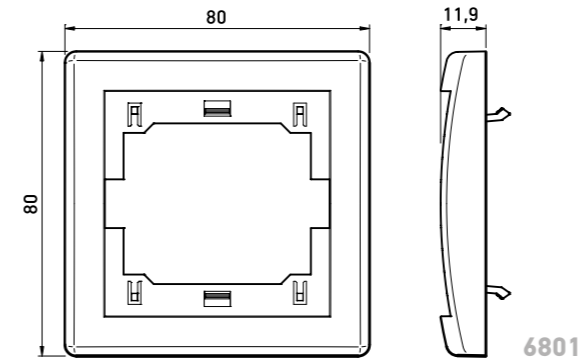
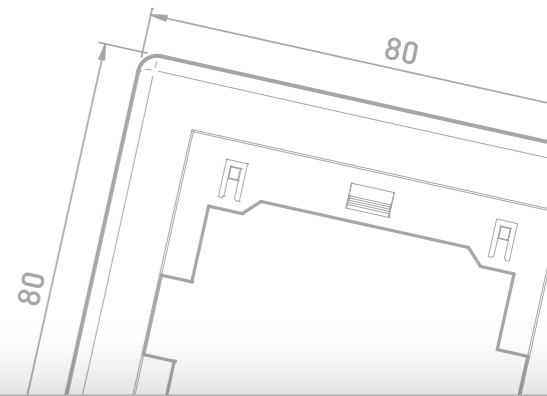

SADRŽAJ KATALOGA  
**PRESTIGE LINE**  
THE CATALOG CONTENT

- 6 TEHNIČKE PREDNOSTI  
*TECHNICAL ADVANTAGES*
- 7 BOJE PREDNJIH ELEMENATA  
*FRONT ELEMENTS COLORS*
- 8 STANDARDNE BOJE  
*STANDARD COLORS*
- 10 SKLOPKE  
*SWITCHES*
- 12 ELEKTRONIKA  
*ELECTRONICS*
- 13 PRIKLJUČNICE  
*SOCKET OUTLETS*
- 15 KOMUNIKACIJE  
*COMMUNICATIONS*
- 17 MEHANIZMI BEZ MASKE I MEĐURAMA  
*MECHANISMS WITHOUT COVER FRAME AND INTERFRAME*
- 22 MASKE I MEĐURAMOVI  
*COVER FRAMES AND INTERFRAMES*
- 24 ŠEME VEZIVANJA  
*WIRING DIAGRAMS*
- 27 DIMENZIJE ZA UGRADNJU  
*INSTALLATION DIMENSIONS*
- 29 TEHNIČKI CRTEŽI  
*TECHNICAL DRAWINGS*

# PRESTIGE LINE





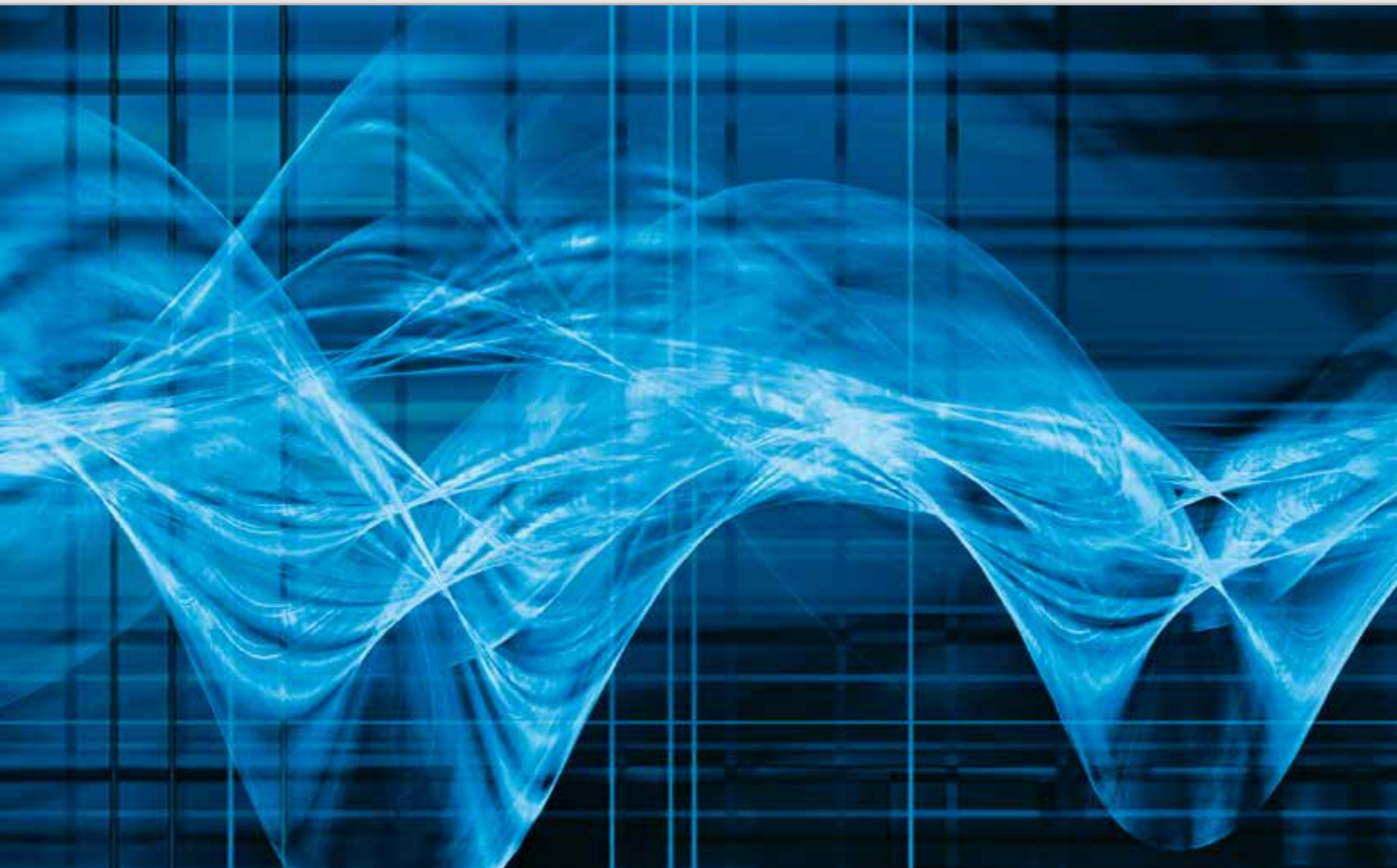

# **ALING-CONEL**

a: Železnička 10, 21432 Gajdobra, Serbia  
t: +381 21 762 674, 762 586  
f: +381 21 762 779  
e: [sales@aling-conel.com](mailto:sales@aling-conel.com)  
[www.aling-conel.com](http://www.aling-conel.com)